

**SIRIO** Luce  
Italian Style

**SPOT LIGHTS**



**012Q-XTD03**

LED: OSRAM  
 Size: 70.5x30x32mm  
 Cutout: 65x25mm  
 Input: 220~240VAC  
 Watt: 5W  
 Beam Angle: 24°/50°  
 CCT: 2700-5500K  
 RA≥90

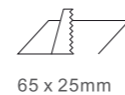
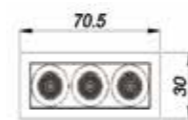
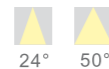

65 x 25mm

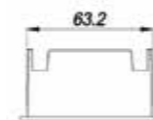

Fixed



Certificate mark



IP rating



Different light distributions



Excellent thermal management



Excellent visual comfort

Grille spotlight series

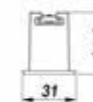
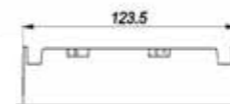
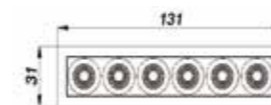

**012Q-XTD06**

LED: OSRAM  
 Size: 131x31x31.6mm  
 Cutout: 125x25mm  
 Input: 220~240VAC  
 Watt: 12W  
 Beam Angle: 24°/50°  
 CCT: 2700-5500K  
 RA≥90

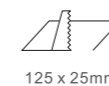

125 x 25mm

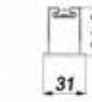
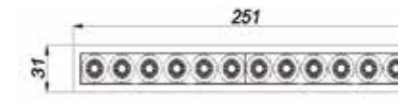

**012Q-XTD12**

LED: OSRAM  
 Size: 251x31x31.6mm  
 Cutout: 245x25mm  
 Input: 220~240VAC  
 Watt: 24W  
 Beam Angle: 24°/50°  
 CCT: 2700-5500K  
 RA≥90



245 x 25mm



DIMMABLE

- 1 Non-Dim
- 2 0-10 V Dim
- 3 Triac dim
- 4 Dali dim
- 5 Mesh

FEATURES



tuya BLE Mesh app



Fixed



Certificate mark



IP rating



Different light distributions



Excellent thermal management



Excellent visual comfort

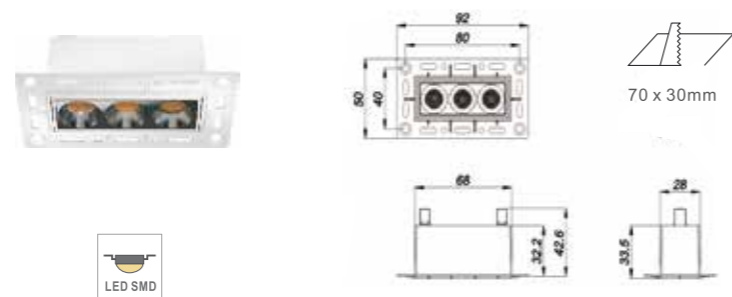

### 013Q-XTD03

LED: OSRAM  
 Size: 92x50x33.5mm  
 Cutout: 70x30mm  
 Input: 220~240VAC  
 Watt: 5W  
 Beam Angle: 24°/50°  
 CCT: 2700-5500K  
 RA≥90

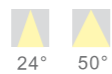

### Grille spotlight series

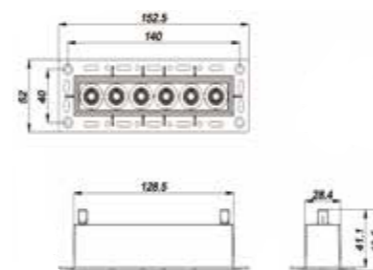

### 013Q-XTD06

LED: OSRAM  
 Size: 152.5x52x33.5mm  
 Cutout: 130x30mm  
 Input: 220~240VAC  
 Watt: 12W  
 Beam Angle: 24°/50°  
 CCT: 2700-5500K  
 RA≥90

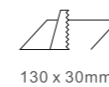

- DIMMABLE
- 1 Non-Dim
  - 2 0-10 V Dim
  - 3 Triac dim
  - 4 Dali dim
  - 5 Mesh

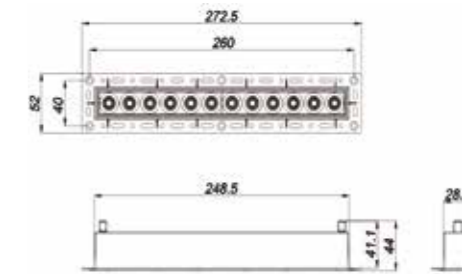

### 013Q-XTD12

LED: OSRAM  
 Size: 272.5x52x33.5mm  
 Cutout: 250x30mm  
 Input: 220~240VAC  
 Watt: 24W  
 Beam Angle: 24°/50°  
 CCT: 2700-5500K  
 RA≥90

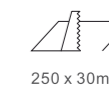

### FEATURES





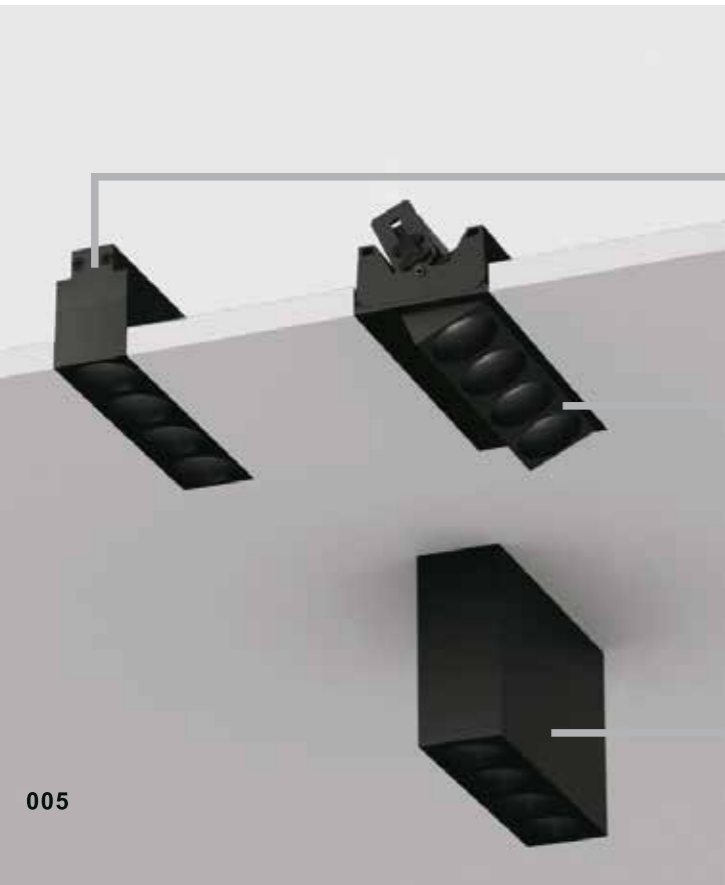

Fixed

Adjustable

Surface



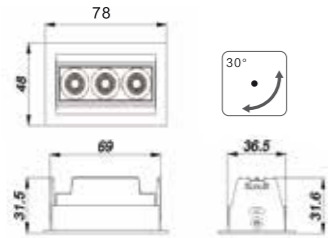

014Q-XTD03

LED: OSRAM  
 Size: 78x48x31.6mm  
 Cutout: 72x40mm  
 Input: 220~240VAC  
 Watt: 5W  
 Beam Angle: 24°/50°  
 CCT: 2700-5500K  
 RA≥90

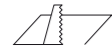

72 x 40mm

**DIMMABLE**

- 1 Non-Dim
- 2 0-10 V Dim
- 3 Triac dim
- 4 Dali dim
- 5 Mesh

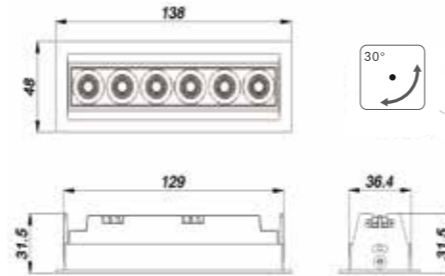

014Q-XTD06

LED: OSRAM  
 Size: 138x48x31.6mm  
 Cutout: 132x40mm  
 Input: 220~240VAC  
 Watt: 12W  
 Beam Angle: 24°/50°  
 CCT: 2700-5500K  
 RA≥90

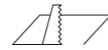

132 x 40mm

FEATURES

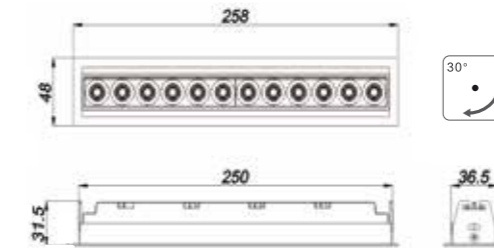

014Q-XTD12

LED: OSRAM  
 Size: 258x48x33.5mm  
 Cutout: 252x40mm  
 Input: 220~240VAC  
 Watt: 24W  
 Beam Angle: 24°/50°  
 CCT: 2700-5500K  
 RA≥90

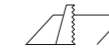

252 x 40mm

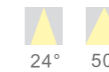

Adjustable



Certificate mark



IP rating



Different light distributions



Excellent thermal management



Excellent visual comfort



Adjustable



Certificate mark



IP rating



Different light distributions



Excellent thermal management



Excellent visual comfort

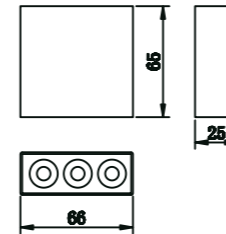

**018M-XTD03**

LED: OSRAM  
 Size: 66x25x65mm  
 Input: 220~240VAC  
 Watt: 3W  
 Beam Angle: 24°/50°  
 CCT: 2700-5500K  
 RA≥90

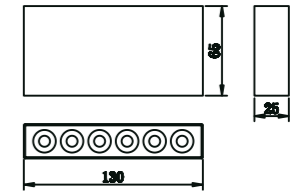

**018M-XTD06**

LED: OSRAM  
 Size: 130x25x65mm  
 Input: 220~240VAC  
 Watt: 6W  
 Beam Angle: 24°/50°  
 CCT: 2700-5500K  
 RA≥90

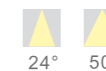

- 1 Non-Dim
- 2 0-10 V Dim
- 3 Triac dim
- 4 Dali dim
- 5 Mesh

**FEATURES**





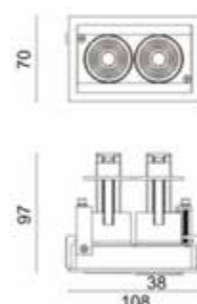

**015Q-TSD-02**

LED: OSRAM/CREE  
 Size: 108x70x97mm  
 Cutout: 98x62mm  
 Input: 220~240VAC  
 Watt: 2x5W  
 Beam Angle: 15°/24°/40°  
 CCT: 2700-5500K  
 RA≥90

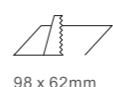

98 x 62mm

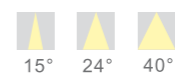

- 1 Non-Dim
- 2 0-10 V Dim
- 3 Triac dim
- 4 Dali dim
- 5 Mesh

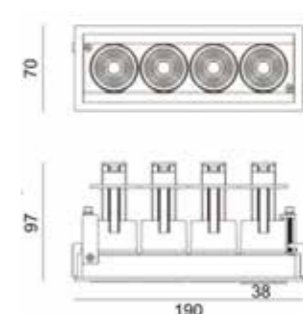

**015Q-TSD-04**

LED: OSRAM/CREE  
 Size: 190x70x97mm  
 Cutout: 182x62mm  
 Input: 220~240VAC  
 Watt: 4x5W  
 Beam Angle: 12°/24°/40°  
 CCT: 2700-5500K  
 RA≥90



182 x 62mm

**FEATURES**

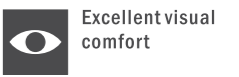



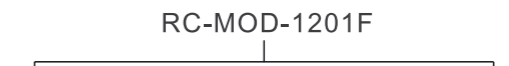

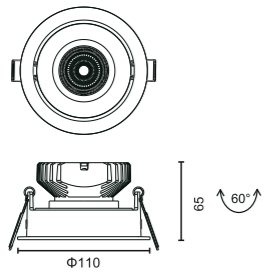

**RC-MOD-RE1201**

LED: OSRAM/CREE  
 Size: Φ110x65mm  
 Cutout: Φ100mm  
 Input: 220~240VAC  
 Watt: 12W  
 Beam Angle: 15°/24°/36°/60°  
 CCT: 2700-5500K  
 RA≥90



- DIMMABLE**
- 1 Non-Dim
  - 2 0-10 V Dim
  - 3 Triac dim
  - 4 Dali dim
  - 5 Mesh

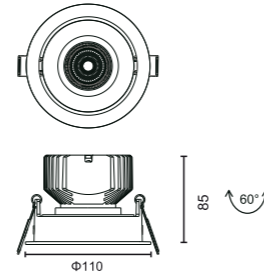

**RC-MOD-RE2001**

LED: OSRAM/CREE  
 Size: Φ110x85mm  
 Cutout: Φ100mm  
 Input: 220~240VAC  
 Watt: 20W  
 Beam Angle: 15°/24°/36°/60°  
 CCT: 2700-5500K  
 RA≥90



**FEATURES**



Adjustable



Certificate mark



IP rating



Different light colours



Excellent thermal management



Excellent visual comfort

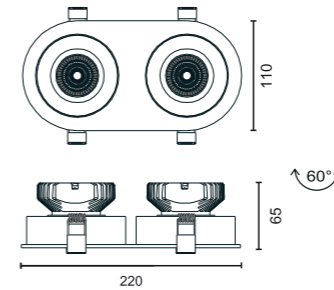

**RC-MOD-RE1202**

LED: OSRAM/CREE  
 Size: 220x110x65mm  
 Cutout: 2xΦ100-110mm  
 Input: 220~240VAC  
 Watt: 2x12W  
 Beam Angle: 15°/24°/36°/60°  
 CCT: 2700-5500K  
 RA≥90

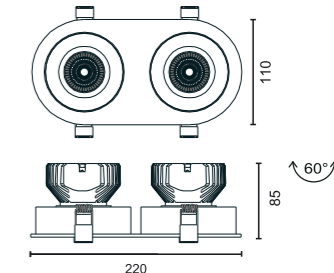

**RC-MOD-RE2002**

LED: OSRAM/CREE  
 Size: 220x110x85mm  
 Cutout: 2xΦ100-110mm  
 Input: 220~240VAC  
 Watt: 2x20W  
 Beam Angle: 15°/24°/36°/60°  
 CCT: 2700-5500K  
 RA≥90

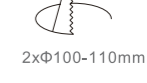

Adjustable



Certificate mark



IP rating



Different light colours



Excellent thermal management



Excellent visual comfort

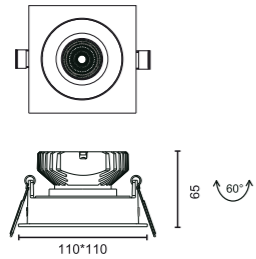

**RC-MOD-RE1203**

LED: OSRAM/CREE  
 Size: 110x110x65mm  
 Cutout:  $\Phi$ 100mm  
 Input: 220~240VAC  
 Watt: 12W  
 Beam Angle: 15°/24°/36°/60°  
 CCT: 2700-5500K  
 RA $\geq$ 90



$\Phi$ 100mm

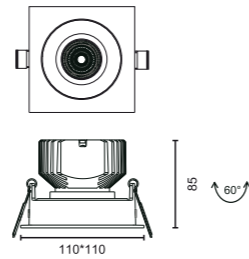

**RC-MOD-RE2003**

LED: OSRAM/CREE  
 Size: 110x110x85mm  
 Cutout:  $\Phi$ 100mm  
 Input: 220~240VAC  
 Watt: 20W  
 Beam Angle: 15°/24°/36°/60°  
 CCT: 2700-5500K  
 RA $\geq$ 90



$\Phi$ 100mm

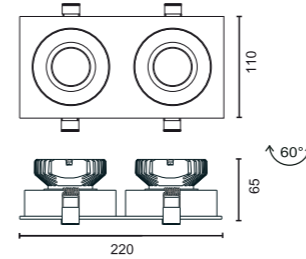

**RC-MOD-RE1204**

LED: OSRAM/CREE  
 Size: 220x110x65mm  
 Cutout: 210-110mm  
 Input: 220~240VAC  
 Watt: 2x12W  
 Beam Angle: 15°/24°/36°/60°  
 CCT: 2700-5500K  
 RA $\geq$ 90

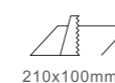

210x100mm

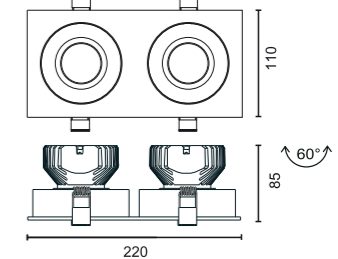

**RC-MOD-RE2004**

LED: OSRAM/CREE  
 Size: 220x110x85mm  
 Cutout: 210-100mm  
 Input: 220~240VAC  
 Watt: 2x20W  
 Beam Angle: 15°/24°/36°/60°  
 CCT: 2700-5500K  
 RA $\geq$ 90

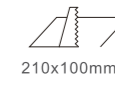

210x100mm

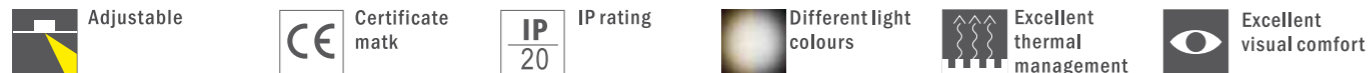





# MINI SPOT

Light

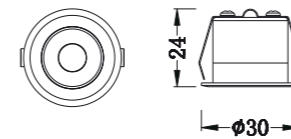

024Q-SD25-02

LED: OSRAM  
 Size:  $\Phi 30 \times 124$ mm  
 Cutout:  $\Phi 25$ mm  
 Input: 220~240VAC  
 Watt: 2W  
 Beam Angle: 15°/27°/60°  
 CCT: 2700-5500K  
 RA $\geq$ 90



- DIMMABLE
- 1 Non-Dim
  - 2 0-10 V Dim
  - 3 Triac dim
  - 4 Dali dim
  - 5 Mesh

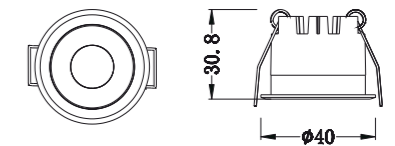

024Q-SD35-04

LED: OSRAM  
 Size:  $\Phi 40 \times 30.8$ mm  
 Cutout:  $\Phi 35$ mm  
 Input: 220~240VAC  
 Watt: 4W  
 Beam Angle: 15°/25°/50°  
 CCT: 2700-5500K  
 RA $\geq$ 90



## FEATURES

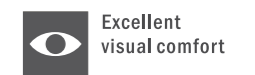
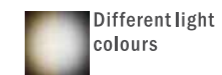

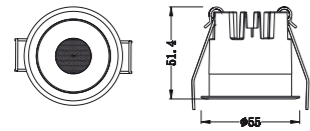

024Q-SD50-05

LED: OSRAM  
Size:  $\Phi 55 \times 51.4 \text{mm}$   
Cutout:  $\Phi 50 \text{mm}$   
Input: 220~240VAC  
Watt: 5W  
Beam Angle: 8°/25°/45°  
CCT: 2700-5500K  
RA $\geq$ 90

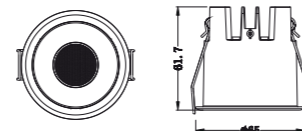
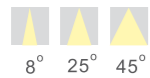

024Q-SD60-08

LED: OSRAM/CREE  
Size:  $\Phi 65 \times 61.7 \text{mm}$   
Cutout:  $\Phi 60 \text{mm}$   
Input: 220~240VAC  
Watt: 8W  
Beam Angle: 20°/45°  
CCT: 2700-5500K  
RA $\geq$ 90

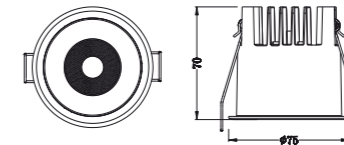
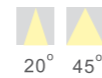

024Q-SD70-12

LED: OSRAM/CREE  
Size:  $\Phi 75 \times 70 \text{mm}$   
Cutout:  $\Phi 70 \text{mm}$   
Input: 220~240VAC  
Watt: 12W  
Beam Angle: 15°/24°/45°  
CCT: 2700-5500K  
RA $\geq$ 90

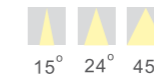

Fixed



Certificate mark



IP rating



Different light colours



Excellent thermal management



Excellent visual comfort



Fixed



Certificate mark



IP rating



Different light colours



Excellent thermal management



Excellent visual comfort

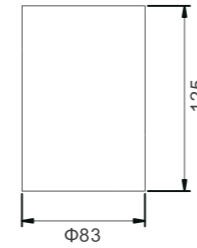

### 016M-TD-15

LED: OSRAM/CREE  
Size:  $\Phi 83 \times 125$ mm  
Input: 220~240VAC 50/60Hz  
Watt: 15W  
Beam Angle: 40°  
CCT: 2700-5500K  
RA $\geq$ 90

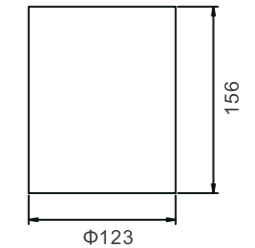

### 016M-TD-20

LED: OSRAM/CREE  
Size:  $\Phi 123 \times 156$ mm  
Input: 220~240VAC 50/60Hz  
Watt: 20W  
Beam Angle: 40°  
CCT: 2700-5500K  
RA $\geq$ 90



- 1 Non-Dim
- 2 0-10 V Dim
- 3 Triac dim
- 4 Dali dim
- 5 Mesh

### FEATURES



tuya BLE Mesh app



Fixed



Certificate mark



IP rating



Different light distributions



Excellent thermal management



Excellent visual comfort



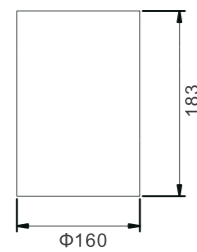

016M-TD-40

LED: OSRAM/CREE  
 Size: Φ160x183mm  
 Input: 220~240VAC 50/60Hz  
 Watt: 40W  
 Beam Angle: 40°  
 CCT: 2700-5500K  
 RA≥90

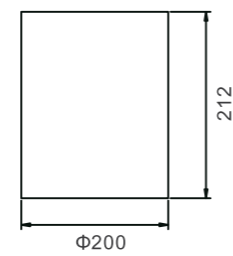

016M-TD-50

LED: OSRAM/CREE  
 Size: Φ200x212mm  
 Input: 220~240VAC 50/60Hz  
 Watt: 50W  
 Beam Angle: 40°  
 CCT: 2700-5500K  
 RA≥90

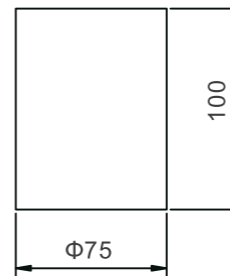
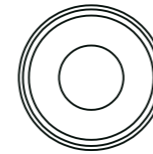

017M-SD-08

LED: OSRAM/CREE  
 Size: Φ75x100mm  
 Input: 220~240VAC 50/60Hz  
 Watt: 8/12W  
 Beam Angle: 24°/50°  
 CCT: 2700-5500K  
 RA≥90

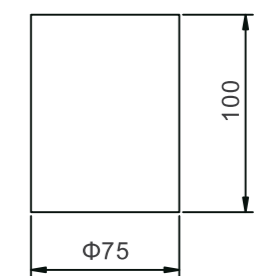
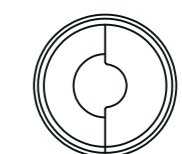
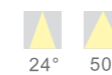

017M-XQ-08

LED: OSRAM/CREE  
 Size: Φ75x100mm  
 Input: 220~240VAC 50/60Hz  
 Watt: 8/12W  
 Beam Angle: Wallwasher  
 CCT: 2700-5500K  
 RA≥90





### 019M-GDSD-10

LED: OSRAM/CREE  
 Size:  $\Phi 50 \times 130 \text{mm}$   
 Input: 220~240VAC 50/60Hz  
 Watt: 10W  
 Beam Angle: 12°/24°/40°  
 CCT: 2700-5500K  
 RA $\geq$ 90

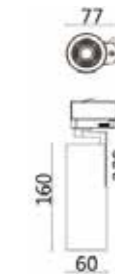

### 019M-GDSD-20

LED: OSRAM/CREE  
 Size:  $\Phi 60 \times 160 \text{mm}$   
 Input: 220~240VAC 50/60Hz  
 Watt: 20W  
 Beam Angle: 12°/24°/40°  
 CCT: 2700-5500K  
 RA $\geq$ 90

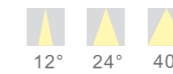

Adjustable



Certificate mark



IP rating



Different light distributions



Easy installation



Excellent visual comfort

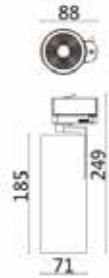

### 019M-GDSD-30

LED: OSRAM/CREE  
Size:  $\Phi 71 \times 185 \text{mm}$   
Input: 220~240VAC 50/60Hz  
Watt: 30W  
Beam Angle: 12°/24°/40°  
CCT: 2700-5500K  
RA $\geq$ 90



### 019M-GDSD-35

LED: OSRAM/CREE  
Size:  $\Phi 83 \times 188 \text{mm}$   
Input: 220~240VAC 50/60Hz  
Watt: 35W  
Beam Angle: 12°/24°/40°  
CCT: 2700-5500K  
RA $\geq$ 90

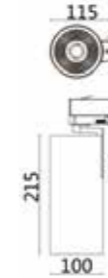
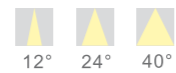

### 019M-GDSD-50

LED: OSRAM/CREE  
Size:  $\Phi 100 \times 215 \text{mm}$   
Input: 220~240VAC 50/60Hz  
Watt: 50W  
Beam Angle: 12°/24°/40°  
CCT: 2700-5500K  
RA $\geq$ 90

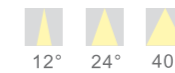

Adjustable



Certificate mark



IP rating



Different light distributions



Easy installation



Excellent visual comfort



Adjustable



Certificate mark



IP rating



Different light distributions



Easy installation



Excellent visual comfort



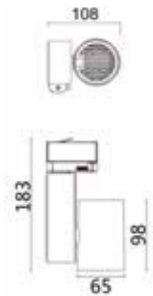

### 020M-GDSD-18

LED: OSRAM/CREE  
Size:  $\Phi 65 \times 95$ mm  
Input: 220~240VAC 50/60Hz  
Watt: 18W  
Beam Angle: 12°/24°/40°  
CCT: 2700-5500K  
RA $\geq$ 90



### 020M-GDSD-18

LED: OSRAM/CREE  
Size:  $\Phi 82 \times 115$ mm  
Input: 220~240VAC 50/60Hz  
Watt: 30W  
Beam Angle: 12°/24°/40°  
CCT: 2700-5500K  
RA $\geq$ 90

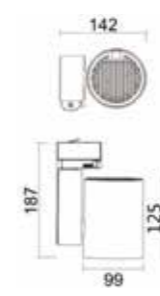

### 020M-GDSD-35

LED: OSRAM/CREE  
Size:  $\Phi 99 \times 125$ mm  
Input: 220~240VAC 50/60Hz  
Watt: 35W  
Beam Angle: 12°/24°/40°  
CCT: 2700-5500K  
RA $\geq$ 90

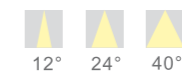
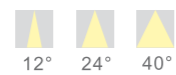

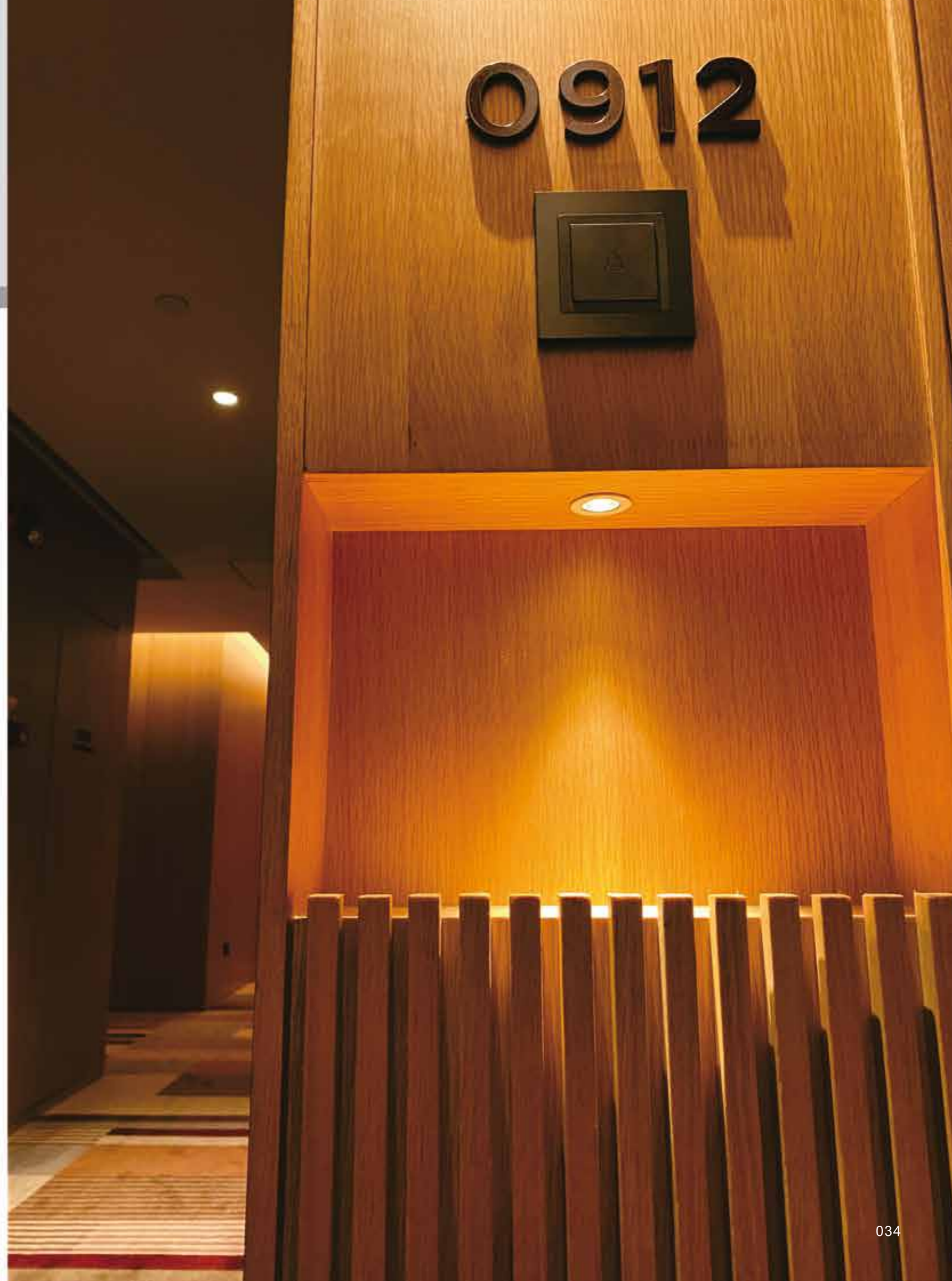
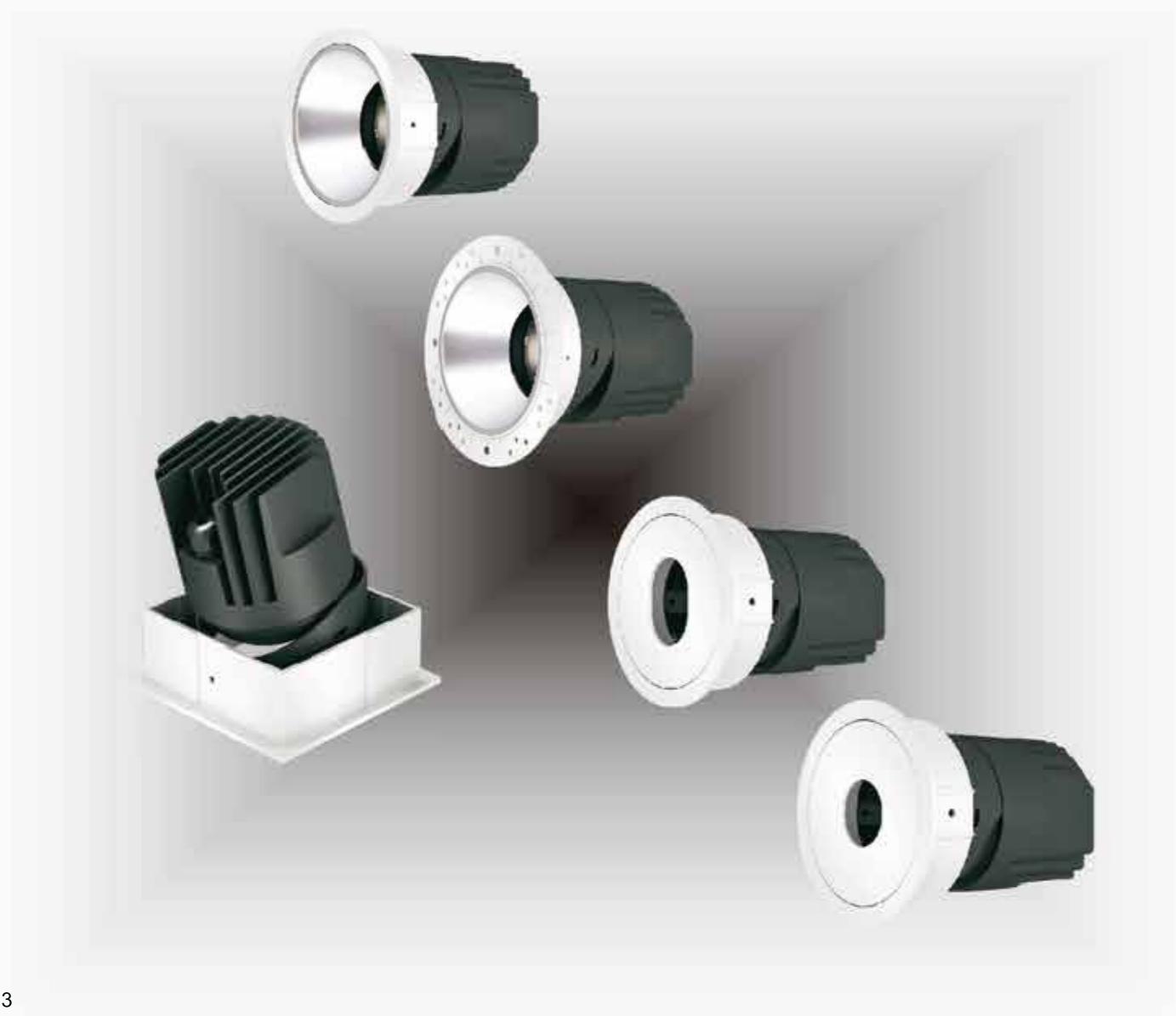

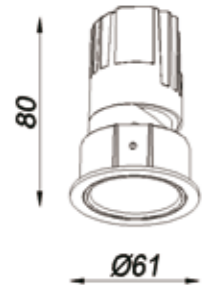

021Q-SD-05

LED: OSRAM/CREE  
Size: Ø61x80mm  
Input: 220~240VAC 50/60Hz  
Watt: 5-8W  
Beam Angle: 15°/24°/36°/50°  
CCT: 2700-5500K  
RA≥90



- 1 Non-Dim
- 2 0-10 V Dim
- 3 Triac dim
- 4 Dali dim
- 5 Mesh

FEATURES



021Q-SD-05-C

LED: OSRAM/CREE  
Size: Ø61x80mm  
Input: 220~240VAC 50/60Hz  
Watt: 5-8W  
Beam Angle: 15°/24°/36°/50°  
CCT: 2700-5500K  
RA≥90

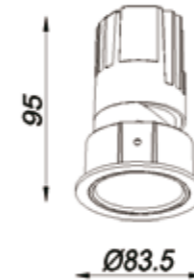

021Q-SD-12

LED: OSRAM/CREE  
Size: Ø83.5x95mm  
Input: 220~240VAC 50/60Hz  
Watt: 10-15W  
Beam Angle: 15°/24°/36°/50°  
CCT: 2700-5500K  
RA≥90

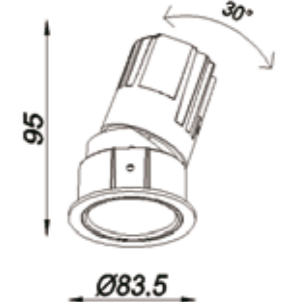
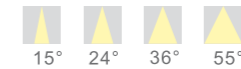

021Q-SD-12-C

LED: OSRAM/CREE  
Size: Ø83.5x95mm  
Input: 220~240VAC 50/60Hz  
Watt: 10-15W  
Beam Angle: 15°/24°/36°/50°  
CCT: 2700-5500K  
RA≥90



Adjustable



Certificate mark



IP rating



Different light distributions



Excellent thermal management



Excellent visual comfort



Adjustable



Certificate mark



IP rating



Different light distributions



Excellent thermal management



Excellent visual comfort



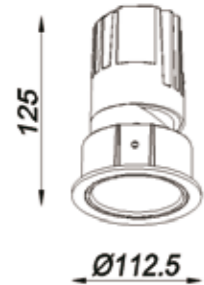

021Q-SD-25

LED: OSRAM/CREE  
Size:  $\Phi 122.5 \times 125$ mm  
Input: 220~240VAC 50/60Hz  
Watt: 18-25W  
Beam Angle: 15°/24°/36°/50°  
CCT: 2700-5500K  
RA $\geq$ 90

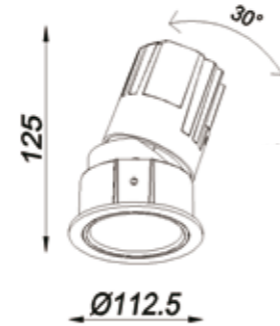
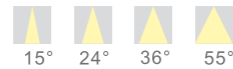

021Q-SD-25-C

LED: OSRAM/CREE  
Size:  $\Phi 112.5 \times 125$ mm  
Input: 220~240VAC 50/60Hz  
Watt: 18-25W  
Beam Angle: 15°/24°/36°/50°  
CCT: 2700-5500K  
RA $\geq$ 90

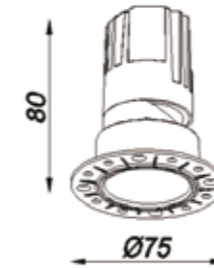

022Q-SD-05

LED: OSRAM/CREE  
Size:  $\Phi 75 \times 80$ mm  
Input: 220~240VAC 50/60Hz  
Watt: 5-8W  
Beam Angle: 15°/24°/36°/50°  
CCT: 2700-5500K  
RA $\geq$ 90

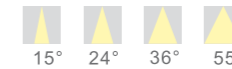

022Q-SD-05

LED: OSRAM/CREE  
Size:  $\Phi 75 \times 80$ mm  
Input: 220~240VAC 50/60Hz  
Watt: 5-8W  
Beam Angle: 15°/24°/36°/50°  
CCT: 2700-5500K  
RA $\geq$ 90



Adjustable



Certificate mark



IP rating



Different light distributions



Excellent thermal management



Excellent visual comfort



Adjustable



Certificate mark



IP rating



Different light distributions



Excellent thermal management



Excellent visual comfort

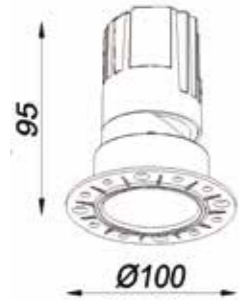

022Q-SD-12

LED: OSRAM/CREE  
Size:  $\Phi 100 \times 95 \text{mm}$   
Input: 220~240VAC 50/60Hz  
Watt: 10-15W  
Beam Angle: 15°/24°/36°/50°  
CCT: 2700-5500K  
RA $\geq$ 90

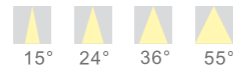

022Q-SD-12-C

LED: OSRAM/CREE  
Size:  $\Phi 100 \times 95 \text{mm}$   
Input: 220~240VAC 50/60Hz  
Watt: 10-15W  
Beam Angle: 15°/24°/36°/50°  
CCT: 2700-5500K  
RA $\geq$ 90

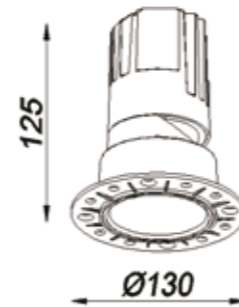

022Q-SD-25

LED: OSRAM/CREE  
Size:  $\Phi 130 \times 125 \text{mm}$   
Input: 220~240VAC 50/60Hz  
Watt: 18-25W  
Beam Angle: 15°/24°/36°/50°  
CCT: 2700-5500K  
RA $\geq$ 90

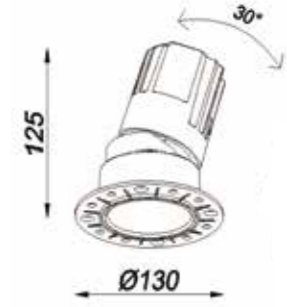
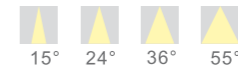

022Q-SD-25-C

LED: OSRAM/CREE  
Size:  $\Phi 130 \times 125 \text{mm}$   
Input: 220~240VAC 50/60Hz  
Watt: 18-25W  
Beam Angle: 15°/24°/36°/50°  
CCT: 2700-5500K  
RA $\geq$ 90



Adjustable



Certificate mark



IP rating



Different light distributions



Excellent thermal management



Excellent visual comfort



Adjustable



Certificate mark



IP rating



Different light distributions



Excellent thermal management



Excellent visual comfort

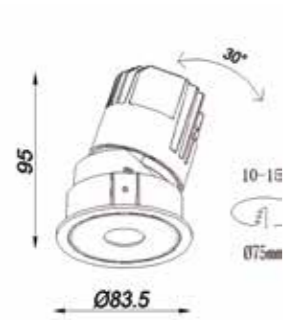

### 023Q-SD-12A

LED: OSRAM/CREE  
Size:  $\Phi 83.5 \times 95$ mm  
Input: 220~240VAC 50/60Hz  
Watt: 10-15W  
Beam Angle: 15°/24°/36°/40°  
CCT: 2700-5500K  
RA $\geq$ 90

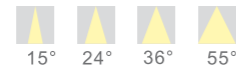

### 023Q-SD-12B

LED: OSRAM/CREE  
Size:  $\Phi 83.5 \times 95$ mm  
Input: 220~240VAC 50/60Hz  
Watt: 10-15W  
Beam Angle: 15°/24°/36°/40°  
CCT: 2700-5500K  
RA $\geq$ 90

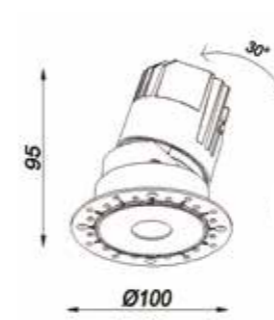

### 023Q-SD-12C

LED: OSRAM/CREE  
Size:  $\Phi 100 \times 95$ mm  
Input: 220~240VAC 50/60Hz  
Watt: 10-15W  
Beam Angle: 15°/24°/36°/40°  
CCT: 2700-5500K  
RA $\geq$ 90

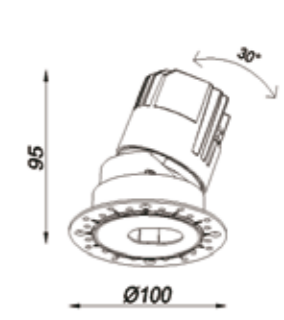
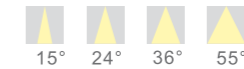

### 023Q-SD-12D

LED: OSRAM/CREE  
Size:  $\Phi 100 \times 95$ mm  
Input: 220~240VAC 50/60Hz  
Watt: 10-15W  
Beam Angle: 15°/24°/36°/40°  
CCT: 2700-5500K  
RA $\geq$ 90



Adjustable



Certificate mark



IP rating



Different light distributions



Excellent thermal management



Excellent visual comfort



Adjustable



Certificate mark



IP rating



Different light distributions



Excellent thermal management



Excellent visual comfort



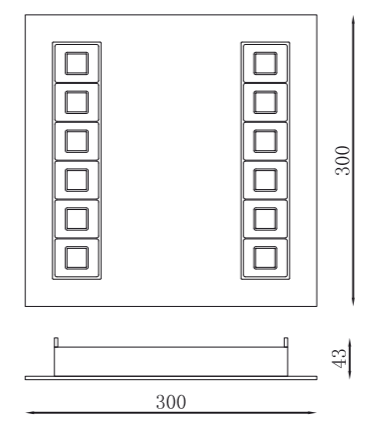

004Q-MB30-WH

Power: 20W  
 Input: 110~277VAC 50/60Hz  
 CCT: 2700-6500K  
 Fitting: Die-cast aluminum ADC12  
 Beam Angle: 60°  
 Color: Matte white  
 Size: 300\*300\*43mm  
 Installation: Recessed

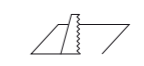

280\*280mm

- DIMMABLE
- 1 Non-Dim
  - 2 0-10 V Dim
  - 3 Triac dim
  - 4 Dali dim
  - 5 Mesh

FEATURES



Fixed



Certificate mark



IP rating  
IP 20



Different light distributions



Excellent thermal management

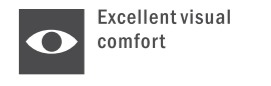

Excellent visual comfort

NEW

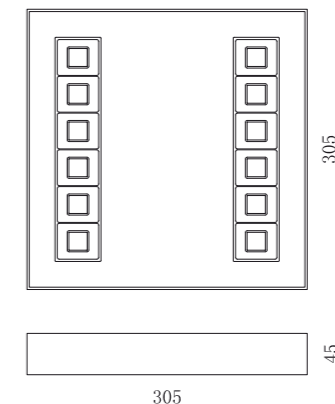

004M-30-WH

Power: 20W  
Input: 110~277VAC 50/60Hz  
CCT: 2700~6500K  
Fitting: Die-cast aluminum ADC12  
Beam Angle: 60°  
Color: Matte white  
Size: 305\*305\*45mm  
Installation: Surface

- DIMMABLE
- 1 Non-Dim
  - 2 0-10 V Dim
  - 3 Triac dim
  - 4 Dali dim
  - 5 Mesh

FEATURES  
 BLE Mesh app

Fixed
 Certificate mark
 IP rating
 Different light distributions
 Excellent thermal management
 Excellent visual comfort



NEW



Nice optical design



High quality chip



Diecast aluminum



Very superb appearance

High-end Office Lighting

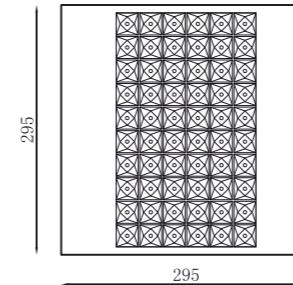
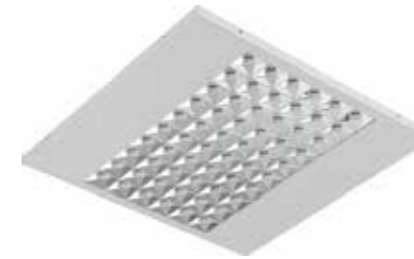

002Q-MB30-WH

Power: 20W  
 Size: 295x295mm  
 Voltage: 110~240VAC 50/60Hz  
 CCT: 3000~6000K  
 Beam Angle: 85°  
 Color rendering index: ≥90  
 LED chip: SMD  
 Installation: Surface/Recessed



285x285mm



- 1 Non-Dim
- 2 0-10 V Dim
- 3 Triac dim
- 4 Dali dim
- 5 Mesh

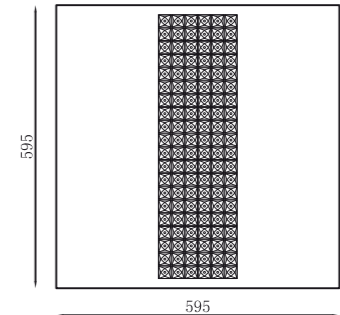

002Q-MB60-WH

Power: 40W  
 Size: 595x595mm  
 Voltage: 110~240VAC 50/60Hz  
 CCT: 3000~6000K  
 Beam Angle: 85°  
 Color rendering index: ≥90  
 LED chip: SMD  
 Installation: Surface/Recessed

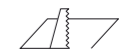

585x585mm

FEATURES



tuya BLE Mesh app



Fixed



Certificate mark



IP rating



Different light distributions



Excellent thermal management

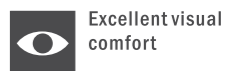

Excellent visual comfort





High-end Office Lighting

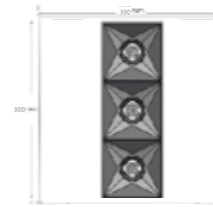

295X295



ROCA007-30

Power: 12W  
 Size: 295x295mm  
 Voltage: 100~240VAC 50/60Hz  
 CCT: 3000~6000K  
 Beam Angle: 86°  
 Color rendering index: ≥90  
 LED chip: SMD  
 Installation: Surface/Recessed

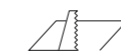

285x285mm

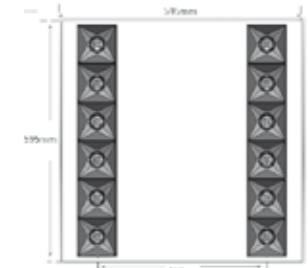

595X595



ROCA007-60

Power: 40W  
 Size: 595x595mm  
 Voltage: 100~240VAC 50/60Hz  
 CCT: 3000~6000K  
 Beam Angle: 86°  
 Color rendering index: ≥90  
 LED chip: SMD  
 Installation: Surface/Recessed

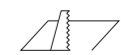

585x585mm



Nice optical design



High quality chip



Diecast aluminum



Very superb appearance



Fixed



Certificate mark



IP rating



Different light distributions



Excellent thermal management



Excellent visual comfort





Magnetic Track Light



MINI TRACK suspended indirect

Size: L1000/2000/3000 mm  
 MATERIAL COLOUR | BK ■ |  
 MATERIAL | AL |



order installation track,  
 light insets+ mounting accessories separately

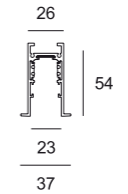

MINI TRACK Trim

Size: L1000/2000/3000 mm  
 MATERIAL COLOUR | BK ■ |  
 MATERIAL | AL |



order installation track,  
 light insets+ mounting accessories separately

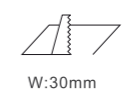

MINI TRACK A Trimless

Size: L1000/2000/3000 mm  
 MATERIAL COLOUR | BK ■ |  
 MATERIAL | AL |



order installation track,  
 light insets+ mounting accessories separately

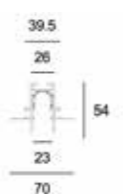
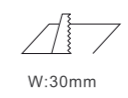

MINI TRACK B Trimless

Size: L1000/2000/3000 mm  
 MATERIAL COLOUR | BK ■ |  
 MATERIAL | AL |



order installation track,  
 light insets+ mounting accessories separately

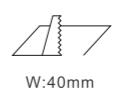

- 1 Non-Dim
- 2 0-10 V Dim
- 3 Triac dim
- 4 Dali dim
- 5 Mesh

FEATURES





SPOT

Magnetic Track Light

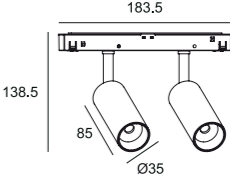
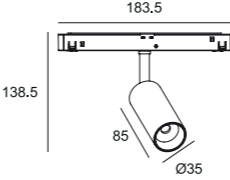







017001A01

Power: 8W  
 Voltage: 48VDC  
 Color temperature: 2700~5500K  
 Beam Angle: 15°/23°/36°/60°  
 Light efficiency: 57 lm/W  
 Color rendering index: ≥90  
 LED chip: COB  
 Installation: Track installation

017001A02

Power: 2\*8W  
 Voltage: 48VDC  
 Color temperature: 2700~5500K  
 Beam Angle: 15°/23°/36°/60°  
 Light efficiency: 57 lm/W  
 Color rendering index: ≥90  
 LED chip: COB  
 Installation: Track installation

-  BK
-  WH
-  BK+GD
-  WH+GD

-  Adjustable
-  48V 48V
-  CE Certificate mark
-  IP 20 IP rating
-  Different light colours
-  Easy installation
-  Excellent visual comfort

Magnetic Track Light

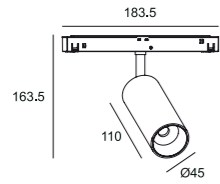

017002A01

Power: 12W  
Voltage: 48VDC  
Color temperature: 2700~5500K  
Beam Angle: 7°/15°/23°/36°/60°  
Light efficiency: 87 lm/W  
Color rendering index: ≥90  
LED chip: COB  
Installation: Track installation

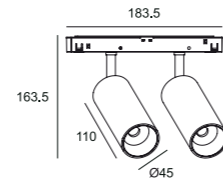

017002A02

Power: 2\*12W  
Voltage: 48VDC  
Color temperature: 2700~5500K  
Beam Angle: 7°/15°/23°/36°/60°  
Light efficiency: 87 lm/W  
Color rendering index: ≥90  
LED chip: COB  
Installation: Track installation

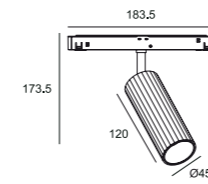

017002B01

Power: 8W  
Voltage: 48VDC  
Color temperature: 2700~5500K  
Beam Angle: 15°/23°/36°/60°  
Light efficiency: 76 lm/W  
Color rendering index: ≥90  
LED chip: COB  
Installation: Track installation

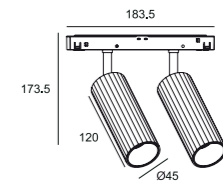

017002B02

Power: 2\*8W  
Voltage: 48VDC  
Color temperature: 2700~5500K  
Beam Angle: 15°/23°/36°/60°  
Light efficiency: 76 lm/W  
Color rendering index: ≥90  
LED chip: COB  
Installation: Track installation

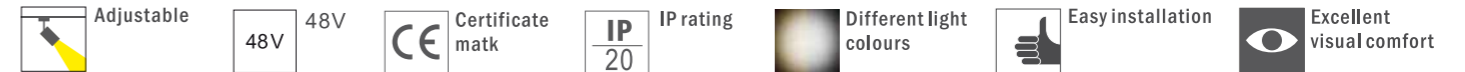
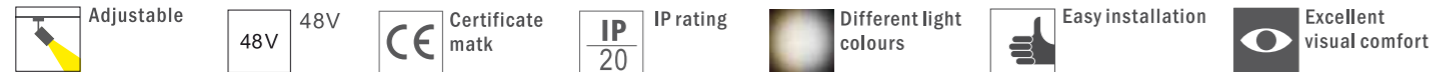



Magnetic Track Light

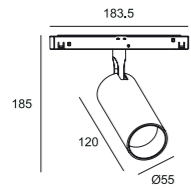

017003A01

Power: 15W  
Voltage: 48VDC  
Color temperature: 2700~5500K  
Beam Angle: 15°/23°/36°/60°  
Light efficiency: 52 lm/W  
Color rendering index: ≥90  
LED chip: COB  
Installation: Track installation

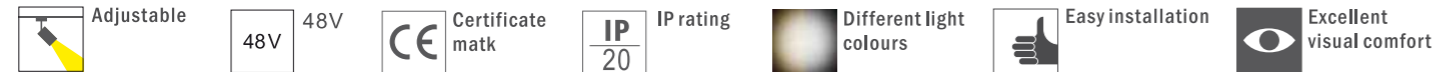

Magnetic Track Light

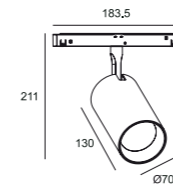

017006A01

Power: 25W  
Voltage: 48VDC  
Color temperature: 2700~5500K  
Beam Angle: 15°/36°/36°/60°  
Light efficiency: 102 lm/W  
Color rendering index: ≥90  
LED chip: COB  
Installation: Track installation

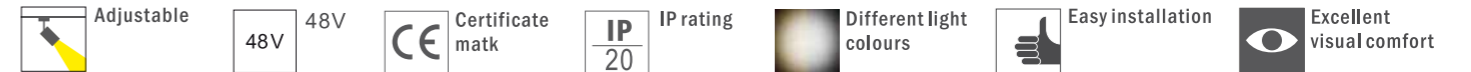



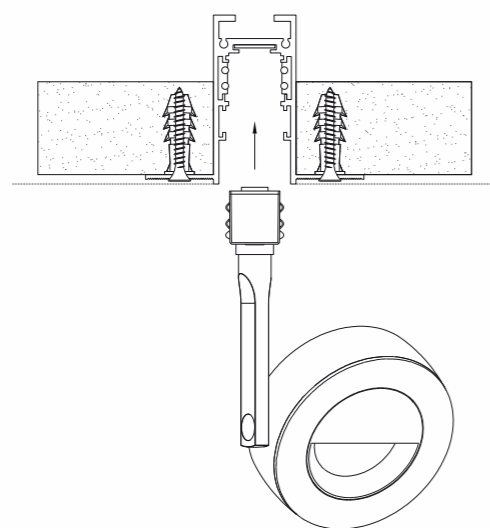

Magnetic Track Light

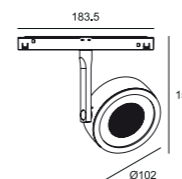

017005A01

Power: 20W  
 Voltage: 48VDC  
 Color temperature: 2700~5500K  
 Beam Angle: 15°/23°/36°/60°  
 Light efficiency: 100 lm/W  
 Color rendering index: ≥90  
 LED chip: COB  
 Installation: Track installation

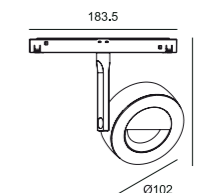

017005B01

Power: 25W  
 Voltage: 48VDC  
 Color temperature: 2700~5500K  
 Beam Angle: wallwasher  
 Light efficiency: 42 lm/W  
 Color rendering index: ≥90  
 LED chip: COB  
 Installation: Track installation



BK



WH



Adjustable



48V 48V



Certificate matk



IP rating



Different light colours



Easy installation



Excellent visual comfort



FOLD



Magnetic Track Light

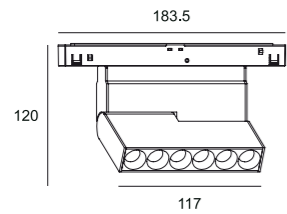

017007A06

Power: 10W  
Voltage: 48VDC  
Color temperature: 2700~5500K  
Beam Angle: 10°/15°/23°/36°/10\*30°  
Light efficiency: 91 lm/W  
Color rendering index: ≥90  
LED chip: COB  
Installation: Track installation

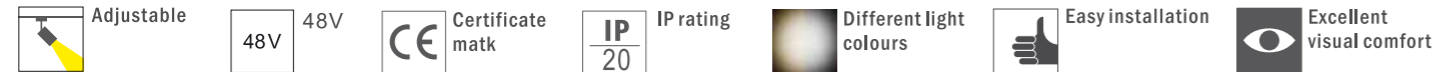

Magnetic Track Light

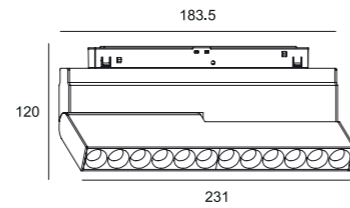

017007A12

Power: 20W  
Voltage: 48VDC  
Color temperature: 2700~5500K  
Beam Angle: 10°/15°/23°/36°/10\*30°  
Light efficiency: 99 lm/W  
Color rendering index: ≥90  
LED chip: COB  
Installation: Track installation

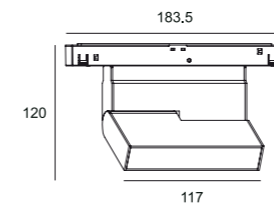

017007B06

Power: 8W  
Voltage: 48VDC  
Color temperature: 3000~6000K  
Beam Angle: 112°  
Light efficiency: 50 lm/W  
Color rendering index: ≥90  
LED chip: COB  
Installation: Track installation

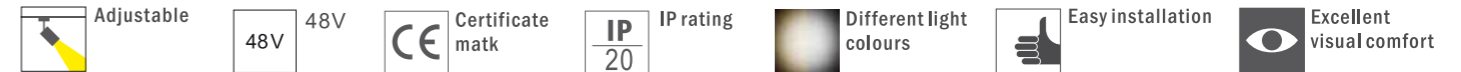





DOT

Magnetic Track Light

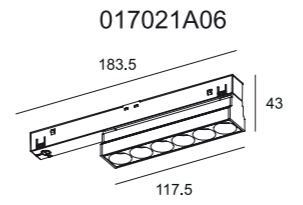

017021A06

Power: 10W  
 Voltage: 48VDC  
 Color temperature: 2700~5500K  
 Beam Angle: 10°/15°/23°/36°/10\*30°  
 Light efficiency: 83 lm/W  
 Color rendering index: ≥90  
 LED chip: COB  
 Installation: Track installation

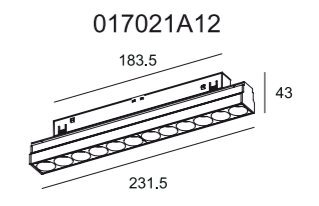

017021A12

Power: 20W  
 Voltage: 48VDC  
 Color temperature: 2700~5500K  
 Beam Angle: 10°/15°/23°/36°/10\*30°  
 Light efficiency: 83 lm/W  
 Color rendering index: ≥90  
 LED chip: COB  
 Installation: Track installation



Fixed

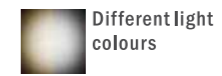
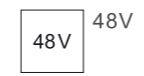



Magnetic Track Light

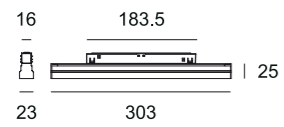

017022A03

Power: 10W  
 Voltage: 48VDC  
 Color temperature: 3000~6000K  
 Beam Angle: 112°  
 Light efficiency: 61 lm/W  
 Color rendering index: ≥90  
 LED chip: COB  
 Installation: Track installation



Fixed
 48V
 Certificate mark
 IP rating
 Different light colours
 Easy installation
 Excellent visual comfort

Magnetic Track Light

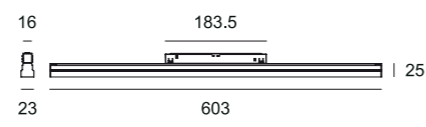

017022A06

Power: 20W  
 Voltage: 48VDC  
 Color temperature: 3000~6000K  
 Beam Angle: 112°  
 Light efficiency: 65 lm/W  
 Color rendering index: ≥80/90  
 LED chip: SMD  
 Installation: Track installation



Fixed
 48V
 Certificate mark
 IP rating
 Different light colours
 Easy installation
 Excellent visual comfort

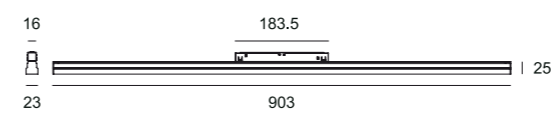

017022A09

Power: 30W  
 Voltage: 48VDC  
 Color temperature: 3000~6000K  
 Beam Angle: 112°  
 Light efficiency: 66 lm/W  
 Color rendering index: ≥80/90  
 LED chip: SMD  
 Installation: Track installation

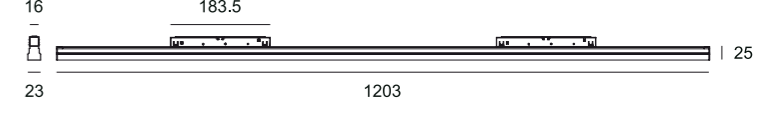

017022A12

Power: 40W  
 Voltage: 48VDC  
 Color temperature: 3000~6000K  
 Beam Angle: 112°  
 Light efficiency: 59 lm/W  
 Color rendering index: ≥80/90  
 LED chip: SMD  
 Installation: Track installation



# CONE

## Magnetic Track Light

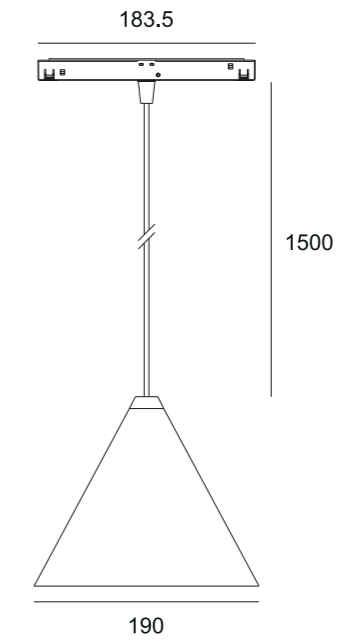

017022A09

Power: 20W  
 Voltage: 48VDC  
 Color temperature: 3000K  
 Beam Angle: 15°/23°/36°/60°  
 Light efficiency: 90 lm/W  
 Color rendering index: ≥90  
 LED chip: COB  
 Installation: Track installation



BK+GD



WH+GD



Fixed



48V



Certificate mark



IP rating



Different light colours



Easy installation



Excellent visual comfort



Magnetic Track Light



**017033A20**



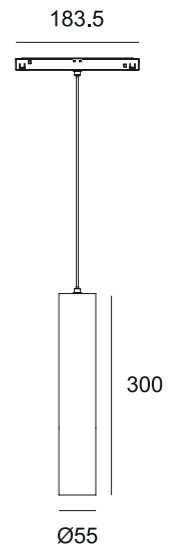



Power: 12W  
 Voltage: 48VDC  
 Color temperature: 2700~5500K  
 Beam Angle: 15°/23°/36°  
 Light efficiency: 78 lm/W  
 Color rendering index: ≥90  
 LED chip: COB  
 Installation: Track installation



**017033A30**

Power: 20W  
 Voltage: 48VDC  
 Color temperature: 2700~5500K  
 Beam Angle: 15°/23°/36°  
 Light efficiency: 74 lm/W  
 Color rendering index: ≥90  
 LED chip: COB  
 Installation: Track installation



 Fixed
  48V 48V
  Certificate mark
  IP rating IP20
  Different light colours
  Easy installation
  Excellent visual comfort

Magnetic Track Light



# MAGNETIC TRACK



Magnetic Track Light

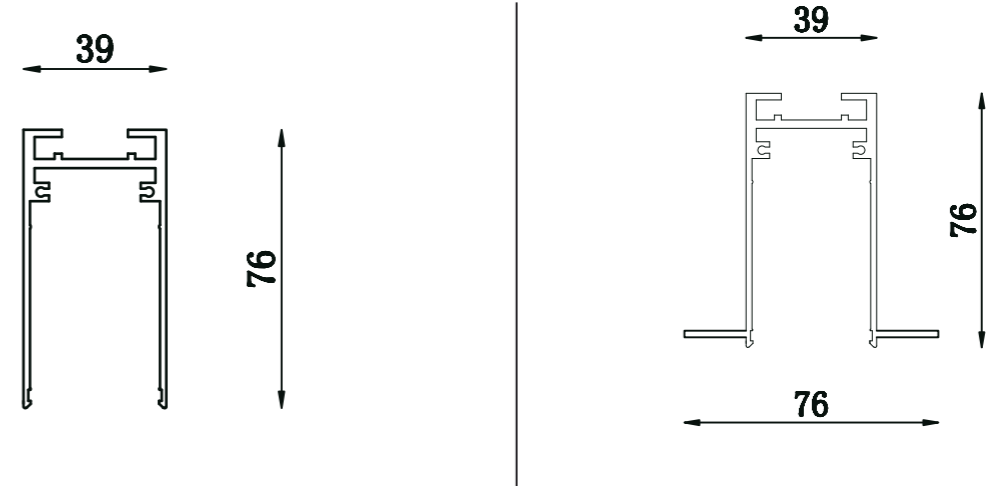

## MAGNETIC TRACK

Siez: L500/1000/2000/3000 \*W39\*H76mm

Installation: Surface/Recessed

MATERIAL COLOUR | Matt white/black

MATERIAL | AL |

- DIMMABLE
- 1 Non-Dim
  - 2 0-10 V Dim
  - 3 Triac dim
  - 4 Dali dim
  - 5 Mesh

### FEATURES





# FOLD



## ROCA-FOLD03

Size: L94\*W34\*H181mm  
 Power: 4W  
 Voltage: 24VDC  
 Color temperature: 2700~5500K  
 Beam Angle: 15°/34°/48°  
 Color rendering index: ≥80/90  
 LED chip: SMD  
 Installation: Magnetic Attraction



## ROCA-FOLD06

Size: L164\*W34\*H181mm  
 Power: 8W  
 Voltage: 24VDC  
 Color temperature: 2700~5500K  
 Beam Angle: 15°/34°/48°  
 Color rendering index: ≥80/90  
 LED chip: SMD  
 Installation: Magnetic Attraction



BK



WH



Adjustable



24V



Certificate mark



IP rating



Different light colours



Easy installation



Excellent visual comfort



ROCA-FOLD13

Size: L323\*W34\*H181mm  
 Power: 16W  
 Voltage: 24VDC  
 Color temperature: 2700~5500K  
 Beam Angle: 15°/34°/48°  
 Color rendering index: ≥80/90  
 LED chip: SMD  
 Installation: Magnetic Attraction



ROCA-FOLD08

Size: L94\*W34\*H181mm  
 Power: 10W  
 Voltage: 24VDC  
 Color temperature: 2700~5500K  
 Diffuser: 3mm Opal acrylic  
 Color rendering index: ≥80/90  
 LED chip: SMD  
 Installation: Magnetic Attraction



ROCA-FOLD16

Size: L164\*W34\*H181mm  
 Power: 20W  
 Voltage: 24VDC  
 Color temperature: 2700~5500K  
 Diffuser: 3mm Opal acrylic  
 Color rendering index: ≥80/90  
 LED chip: SMD  
 Installation: Magnetic Attraction



ROCA-FOLD32

Size: L323\*W34\*H181mm  
 Power: 30W  
 Voltage: 24VDC  
 Color temperature: 2700~5500K  
 Diffuser: 3mm Opal acrylic  
 Color rendering index: ≥80/90  
 LED chip: SMD  
 Installation: Magnetic Attraction



BK



WH



BK



WH

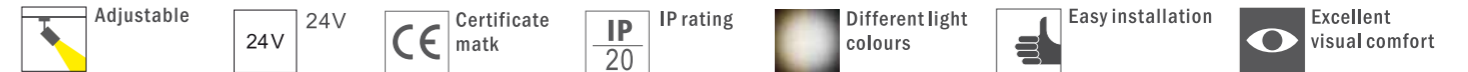
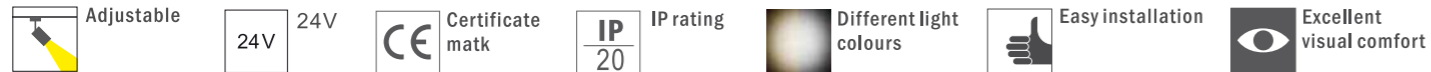



# LINEAR



## ROCA-LINEAR32

Size: L323\*W34\*H56mm  
Power: 15W  
Voltage: 24VDC  
Color temperature: 2700~5500K  
Diffuser: 3mm Opal acrylic  
Color rendering index: ≥80/90  
LED chip: SMD  
Installation: Magnetic Attraction



## ROCA-LINEAR64

Size: L640\*W34\*H56mm  
Power: 30W  
Voltage: 24VDC  
Color temperature: 2700~5500K  
Diffuser: 3mm Opal acrylic  
Color rendering index: ≥80/90  
LED chip: SMD  
Installation: Magnetic Attraction



BK



WH



Fixed

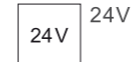

24V



Certificate mark



IP rating



Different light colours

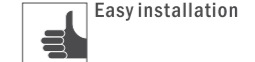

Easy installation

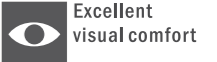

Excellent visual comfort



ROCA-LINEAR96

Size: L959\*W34\*H56mm  
 Power: 45W  
 Voltage: 24VDC  
 Color temperature: 2700~5500K  
 Diffuser: 3mm Opal acrylic  
 Color rendering index: ≥80/90  
 LED chip: SMD  
 Installation: Magnetic Attraction



ROCA-LINEAR32H

Size: L323\*W34\*H110mm  
 Power: 15W  
 Voltage: 24VDC  
 Color temperature: 2700~5500K  
 Diffuser: 3mm Opal acrylic  
 Color rendering index: ≥80/90  
 LED chip: SMD  
 Installation: Magnetic Attraction



ROCA-LINEAR64H

Size: L640\*W34\*H110mm  
 Power: 30W  
 Voltage: 24VDC  
 Color temperature: 2700~5500K  
 Diffuser: 3mm Opal acrylic  
 Color rendering index: ≥80/90  
 LED chip: SMD  
 Installation: Magnetic Attraction



ROCA-LINEAR96H

Size: L959\*W34\*H110mm  
 Power: 45W  
 Voltage: 24VDC  
 Color temperature: 2700~5500K  
 Diffuser: 3mm Opal acrylic  
 Color rendering index: ≥80/90  
 LED chip: SMD  
 Installation: Magnetic Attraction



BK



WH



BK



WH

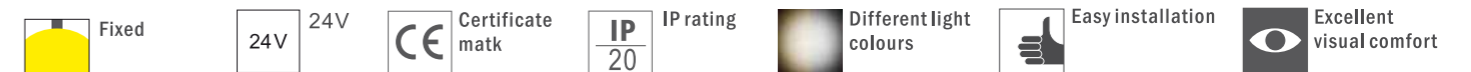
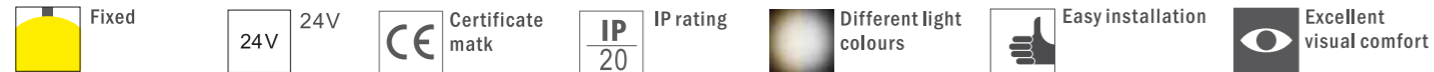





ROCA-WASHER13

Size: L138\*W34\*H56mm  
 Power: 8W  
 Voltage: 24VDC  
 Color temperature: 2700~5500K  
 Beam Angle: Wall washer  
 Color rendering index: ≥80/90  
 LED chip: SMD  
 Installation: Magnetic Attraction



ROCA-WASHER27

Size: L270\*W34\*H56mm  
 Power: 16W  
 Voltage: 24VDC  
 Color temperature: 2700~5500K  
 Beam Angle: Wall washer  
 Color rendering index: ≥80/90  
 LED chip: SMD  
 Installation: Magnetic Attraction



ROCA-WASHER40

Size: L400\*W34\*H56mm  
 Power: 24W  
 Voltage: 24VDC  
 Color temperature: 2700~5500K  
 Beam Angle: Wall washer  
 Color rendering index: ≥80/90  
 LED chip: SMD  
 Installation: Magnetic Attraction



ROCA-WASHER30

Size: L270\*W34\*H110mm  
 Power: 16W  
 Voltage: 24VDC  
 Color temperature: 2700~5500K  
 Beam Angle: Wall washer  
 Color rendering index: ≥80/90  
 LED chip: SMD  
 Installation: Magnetic Attraction

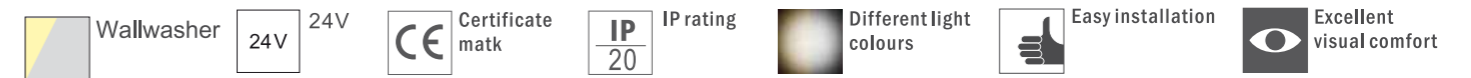
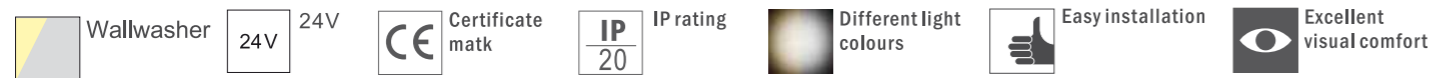



DOT





ROCA-DOT03

Size: L94\*W34\*H56mm  
 Power: 4W  
 Voltage: 24VDC  
 Color temperature: 2700~5500K  
 Beam Angle: 15°/34°/48°  
 Color rendering index: ≥80/90  
 LED chip: SMD  
 Installation: Magnetic Attraction



ROCA-DOT06

Size: L164\*W34\*H56mm  
 Power: 8W  
 Voltage: 24VDC  
 Color temperature: 2700~5500K  
 Beam Angle: 15°/34°/48°  
 Color rendering index: ≥80/90  
 LED chip: SMD  
 Installation: Magnetic Attraction



ROCA-DOT12

Size: L323\*W34\*H56mm  
 Power: 16W  
 Voltage: 24VDC  
 Color temperature: 2700~5500K  
 Beam Angle: 15°/34°/48°  
 Color rendering index: ≥80/90  
 LED chip: SMD  
 Installation: Magnetic Attraction



ROCA-DOT12H

Size: L323\*W34\*H110mm  
 Power: 16W  
 Voltage: 24VDC  
 Color temperature: 2700~5500K  
 Beam Angle: 15°/34°/48°  
 Color rendering index: ≥80/90  
 LED chip: SMD  
 Installation: Magnetic Attraction



BK



WH



BK



WH



Fixed



24V



Certificate mark



IP rating



Different light colours



Easy installation



Excellent visual comfort



Fixed



24V



Certificate mark



IP rating



Different light colours



Easy installation



Excellent visual comfort

# SPOT



## ROCA-SPOT35

Size:  $\Phi 35 \times H 80 \text{mm}$   
 Power: 5W  
 Voltage: 24VDC  
 Color temperature: 2700~5500K  
 Beam Angle: 20°/30°/40°/60°  
 Color rendering index:  $\geq 80/90$   
 LED chip: COB  
 Installation: Magnetic Attraction



## ROCA-SPOT35T

Size:  $\Phi 35 \times H 80 \text{mm}$   
 Power: 2\*5W  
 Voltage: 24VDC  
 Color temperature: 2700~5500K  
 Beam Angle: 20°/30°/40°/60°  
 Color rendering index:  $\geq 80/90$   
 LED chip: COB  
 Installation: Magnetic Attraction



Adjustable



24V



Certificate mark



IP rating



Different light colours



Easy installation



Excellent visual comfort





ROCA-SPOT50

Size:  $\Phi 50 \times H140$ mm  
 Power: 10W  
 Voltage: 24VDC  
 Color temperature: 2700~5500K  
 Beam Angle: 15°/36°/48°  
 Color rendering index:  $\geq 80/90$   
 LED chip: COB  
 Installation: Magnetic Attraction



ROCA-SPOT50-LS

Size:  $\Phi 50 \times H140$ mm  
 Power: 10W  
 Voltage: 24VDC  
 Color temperature: 2700~5500K  
 Beam Angle: 15°/36°/48°  
 Color rendering index:  $\geq 80/90$   
 LED chip: COB  
 Installation: Magnetic Attraction



ROCA-SPOT65-R

Size:  $\Phi 65$ mm  
 Power: 8W  
 Voltage: 24VDC  
 Color temperature: 2700~5500K  
 Beam Angle: 10°/20°/30°  
 Color rendering index:  $\geq 80/90$   
 LED chip: COB  
 Installation: Magnetic Attraction



ROCA-SPOT95-R

Size:  $\Phi 95$ mm  
 Power: 15W  
 Voltage: 24VDC  
 Color temperature: 2700~5500K  
 Beam Angle: 10°/20°/30°  
 Color rendering index:  $\geq 80/90$   
 LED chip: COB  
 Installation: Magnetic Attraction

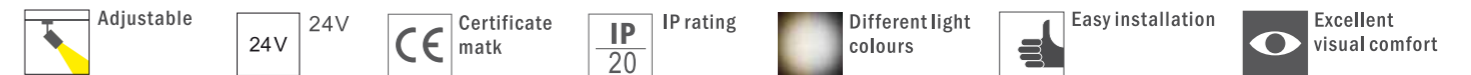
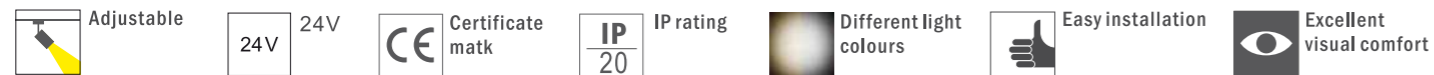



ROCA-Pendant35-R

Size:  $\Phi 35 \times H250\text{mm}$   
 Power: 5W  
 Voltage: 24VDC  
 Color temperature: 2700~5500K  
 Beam Angle: 18°/24°/36°  
 Color rendering index:  $\geq 80/90$   
 LED chip: COB  
 Installation: Magnetic Attraction



ROCA-Pendant50-R

Size:  $\Phi 50 \times H250\text{mm}$   
 Power: 10W  
 Voltage: 24VDC  
 Color temperature: 2700~5500K  
 Beam Angle: 18°/24°/36°  
 Color rendering index:  $\geq 80/90$   
 LED chip: COB  
 Installation: Magnetic Attraction

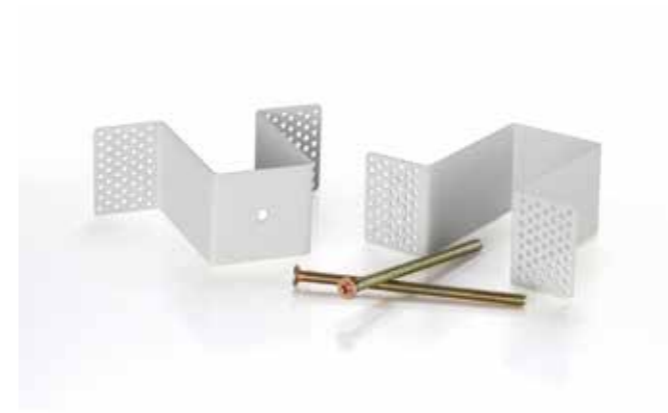

RECESSED KIT



CONNECTOR



RECESSED TRACK



T CORNER

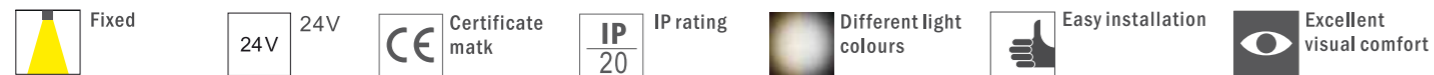



45D CORNER



BL L CORNER R



OUTER CORNER



OUTER CORNER-R



L CORNER



INNER CORNER-R



CROSS CORNER



INNER CORNER



Dimmable



Certificate mark



IP rating



Different light colours



Excellent thermal management



Excellent visual comfort



Dimmable



Certificate mark



IP rating



Different light colours



Excellent thermal management



Excellent visual comfort







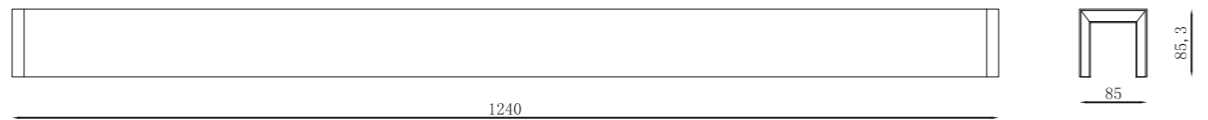

005D-1240-25W

Size: 1240x85x85.3mm  
 Input: 120V-277V  
 Wattage: 25W (75% up / 25% down)  
 Light efficiency: 78.78ml/w  
 CCT: 2700K/3000K/3500K/4000K  
 CRI>80/90

- DIMMABLE**
- 1 Non-Dim
  - 2 0-10 V Dim
  - 3 Triac dim
  - 4 Dali dim
  - 5 Mesh

**FEATURES**



- Fixed
- Certificate mark
- IP rating IP 20
- Different light distributions
- Excellent thermal management
- Excellent visual comfort

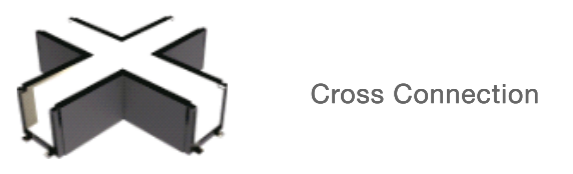
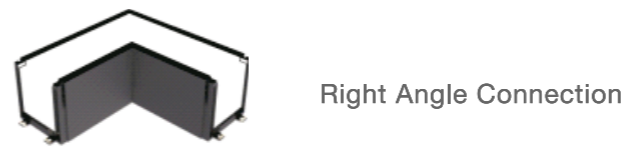
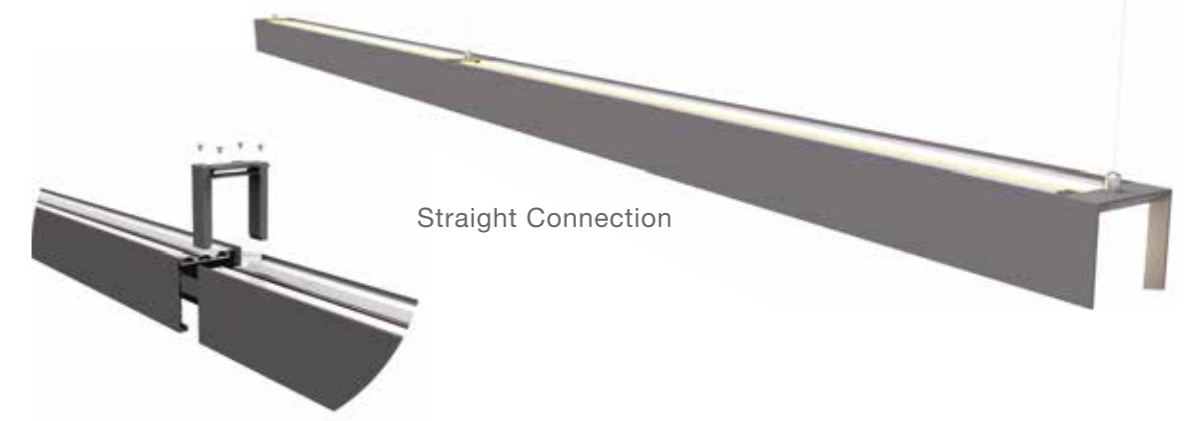

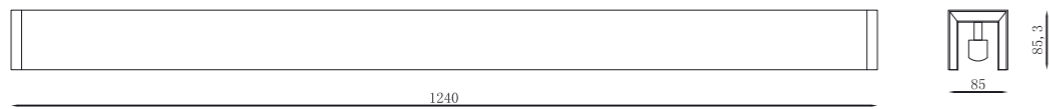
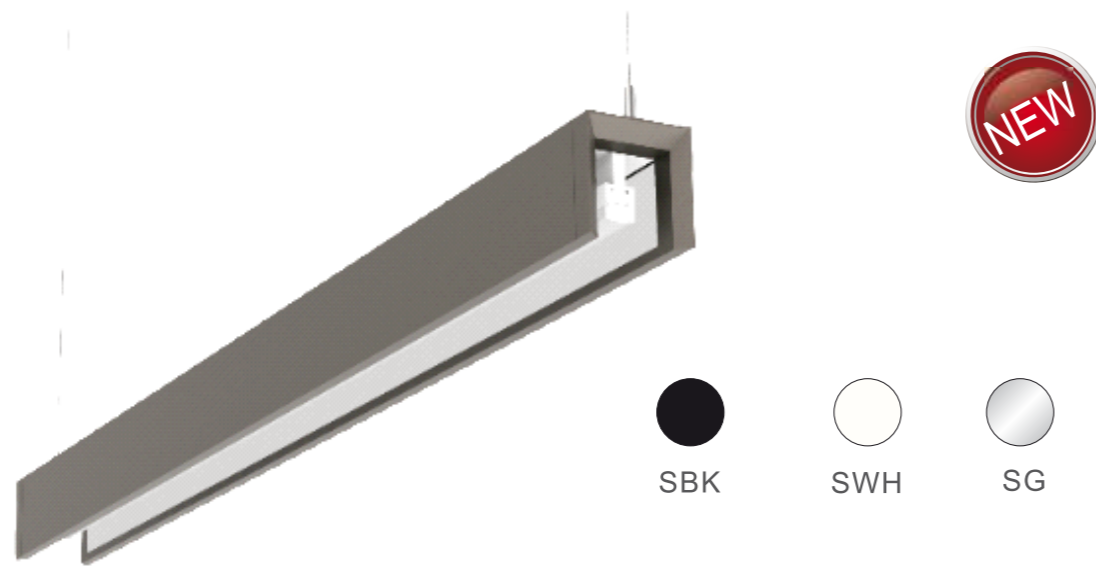

**005D-1240-40W**

Size: 1240x85x85.3mm  
 Input: 120V-277V  
 Wattage: 40W (50% up / 50% down)  
 Light efficiency: 78.78lm/w  
 CCT: 2700K/3000K/3500K/4000K  
 CRI>80/90

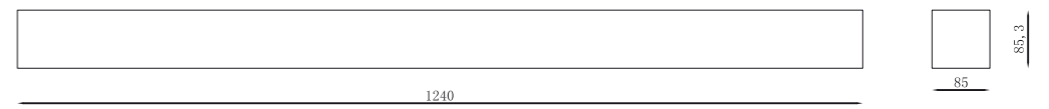
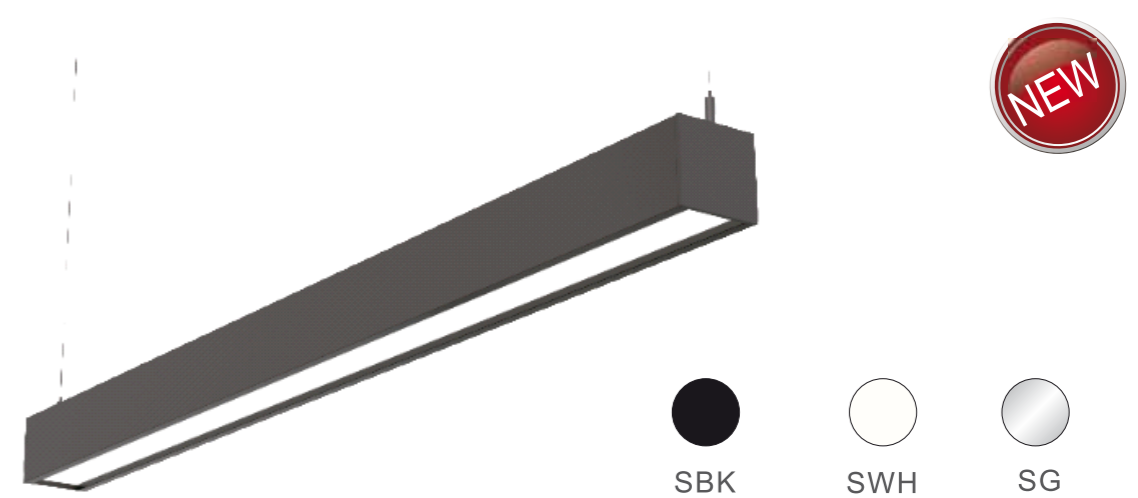

**005D-1240-55W**

Size: 1240x85x85.3mm  
 Input: 120V-277V  
 Wattage: 55W (25% up / 75% down)  
 Light efficiency: 78.78lm/w  
 CCT: 2700K/3000K/3500K/4000K  
 CRI>80/90





  
**IP65**

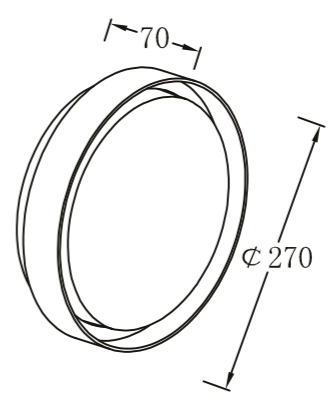

**008M-XD27-R**

LED: LED 2835SMD  
 Size:  $\phi 270 \times 70$ mm  
 Wattage: 20W  
 CCT: 3000K  
 Voltage: 100-240VAC 50/60Hz  
 Material: diecast aluminum  
 Beam Angle: 96°  
 TA: -30°~+50°  
 Color: Silver Grey/Dark Grey/White/Black  
 Installation: Surface



**NEW**



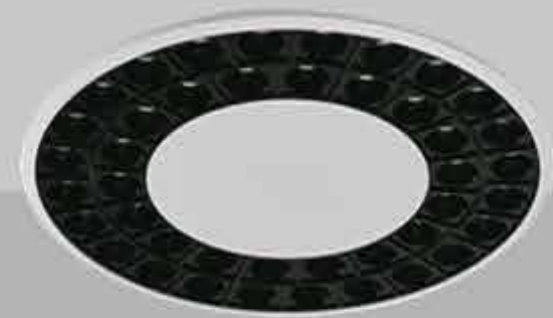
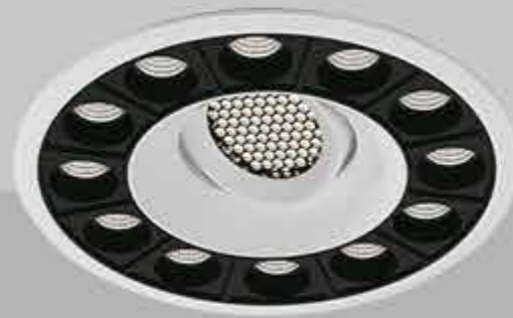
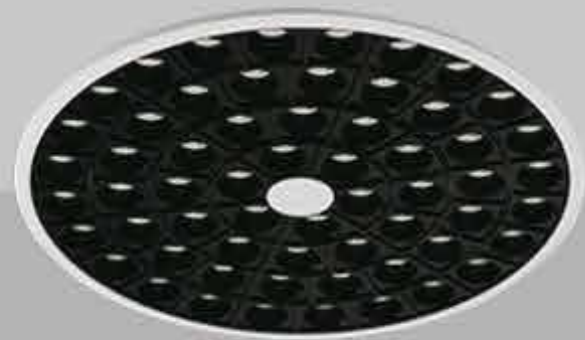



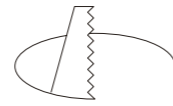
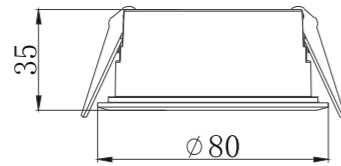
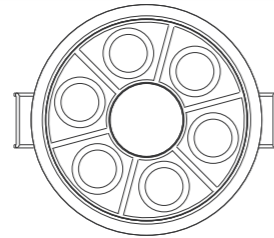

Φ75mm



### 007Q-XTD6A-R

LED: OSRAM  
 Size: Ø80xH35mm  
 Installation: Recessed  
 Wattage: 8W  
 Beam Angle: 24°/34°/48°  
 Input: 220-240VAC 50/60Hz  
 Finish: White  
 Reflector: Black  
 RA: ≥90  
 Material: ADC 12 Alum.  
 UGR: <19

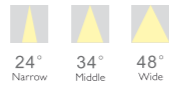

- 1 Non-Dim
- 2 0-10 V Dim
- 3 Triac dim
- 4 Dali dim
- 5 Mesh

### FEATURES



Fixed



Certificate mark



IP rating



Different light distributions



Excellent thermal management



Excellent visual comfort

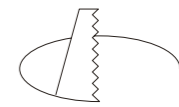
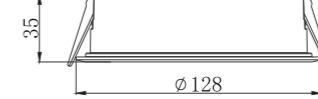
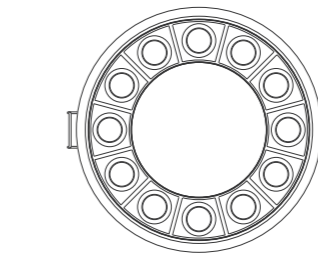

Φ120mm



### 007Q-XTD12A-R

LED: OSRAM  
 Size: Ø128xH35mm  
 Installation: Recessed  
 Wattage: 15W  
 Beam Angle: 24°/34°/48°  
 Input: 220-240VAC 50/60Hz  
 Finish: White  
 Reflector: Black  
 RA: ≥90  
 Material: ADC 12 Alum.  
 UGR: <19

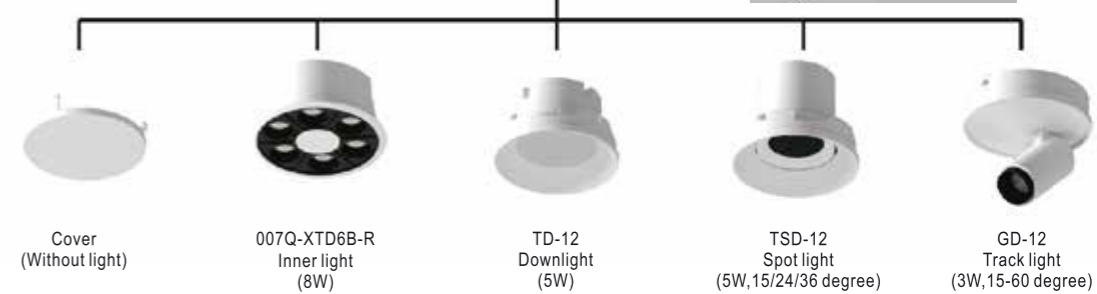

Fixed



Certificate mark



IP rating



Different light distributions



Excellent thermal management



Excellent visual comfort

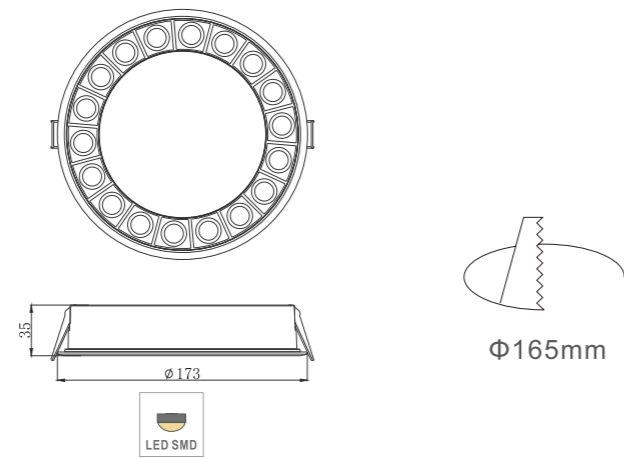

Φ165mm

007Q-XTD18A-R

LED: OSRAM  
 Size: Ø173xH35mm  
 Installation: Recessed  
 Wattage: 20W  
 Beam Angle: 24°/34°/48°  
 Input: 220-240VAC 50/60Hz  
 Finish: White  
 Reflector: Black  
 RA: ≥90  
 Material: ADC 12 Alum.  
 UGR: <19

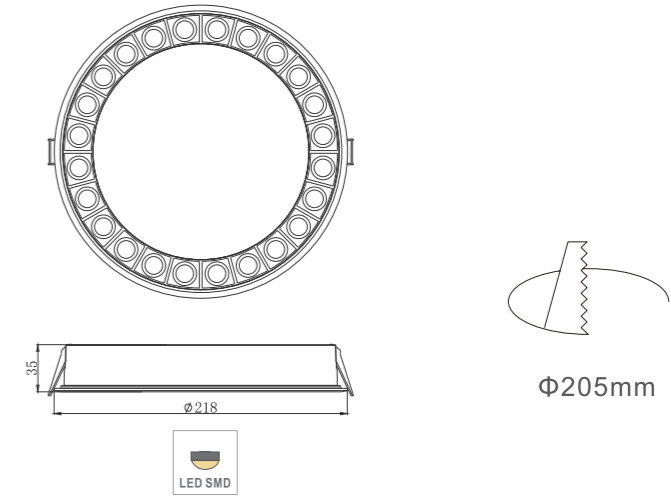

Φ205mm

007Q-XTD24A-R

LED: OSRAM  
 Size: Ø218xH35mm  
 Installation: Recessed  
 Wattage: 30W  
 Beam Angle: 24°/34°/48°  
 Input: 220-240VAC 50/60Hz  
 Finish: White  
 Reflector: Black  
 RA: ≥90  
 Material: ADC 12 Alum.  
 UGR: <19

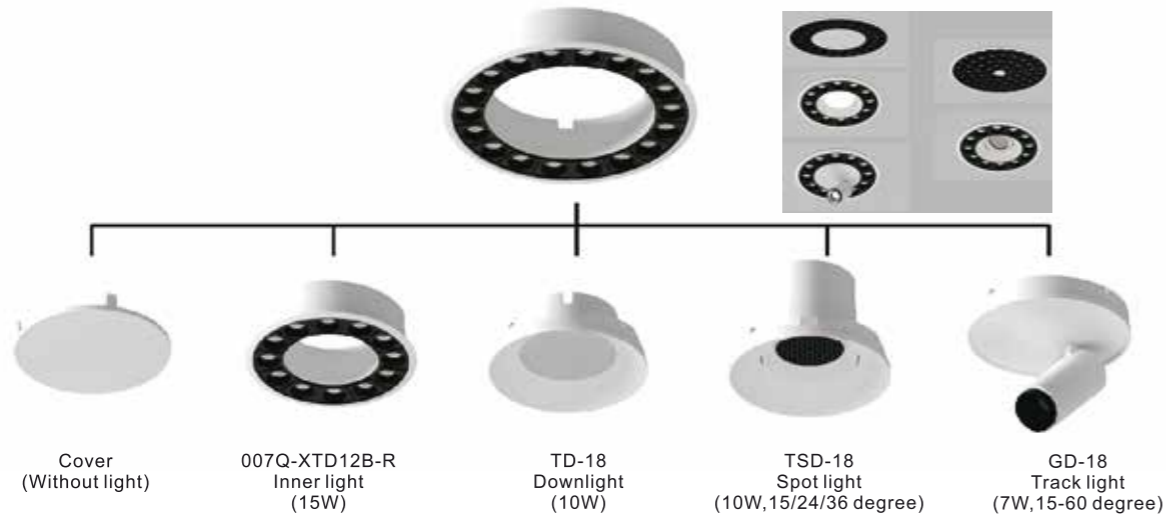

Cover (Without light)    007Q-XTD12B-R Inner light (15W)    TD-18 Downlight (10W)    TSD-18 Spot light (10W, 15/24/36 degree)    GD-18 Track light (7W, 15-60 degree)

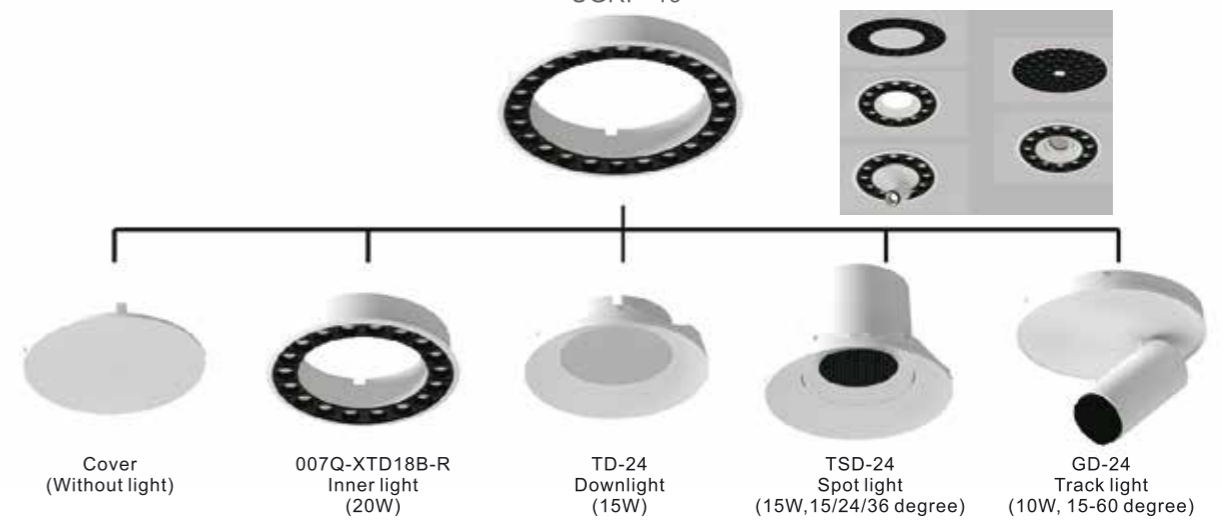

Cover (Without light)    007Q-XTD18B-R Inner light (20W)    TD-24 Downlight (15W)    TSD-24 Spot light (15W, 15/24/36 degree)    GD-24 Track light (10W, 15-60 degree)

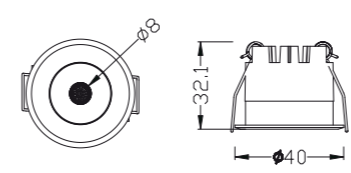

**010Q-STD35**

LED: OSRAM  
 Size:  $\Phi 40 \times 32.1 \text{mm}$   
 Cutout:  $\Phi 35 \text{mm}$   
 Input: 220~240VAC  
 Wattage: 3W  
 Beam Angle: 30°  
 CCT: 2700~5500K  
 RA:  $\geq 90$



- DIMMABLE
- 1 Non-Dim
  - 2 0-10 V Dim
  - 3 Triac dim
  - 4 Dali dim
  - 5 Mesh

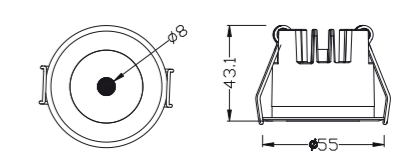

**010Q-STD50**

LED: OSRAM  
 Size:  $\Phi 55 \times 43.1 \text{mm}$   
 Cutout:  $\Phi 50 \text{mm}$   
 Input: 220~240VAC  
 Wattage: 5W  
 Beam Angle: 30°  
 CCT: 2700~5500K  
 RA:  $\geq 90$



**FEATURES**



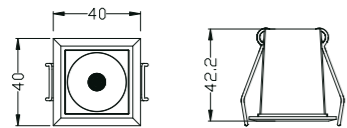
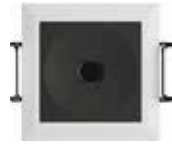

### 010Q-XTD01-3W

LED: OSRAM  
 Size: 40x40x42.2mm  
 Cutout: 35x35mm  
 Input: 220~240VAC  
 Wattage: 3W  
 Beam Angle: 30°  
 CCT: 2700~5500K  
 RA: ≥90

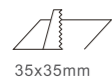

35x35mm



30°

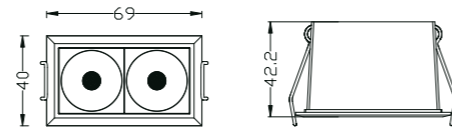

### 010Q-XTD02-5W

LED: OSRAM  
 Size: 69x40x42.2mm  
 Cutout: 65x35mm  
 Input: 220~240VAC  
 Wattage: 5W  
 Beam Angle: 30°  
 CCT: 2700~5500K  
 RA: ≥90

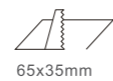

65x35mm

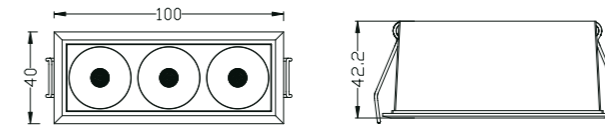

### 010Q-XTD03-8W

LED: OSRAM  
 Size: 100x40x42.2mm  
 Cutout: 95x35mm  
 Input: 220~240VAC  
 Wattage: 8W  
 Beam Angle: 30°  
 CCT: 2700~5500K  
 RA: ≥90



95x35mm



30°



Fixed



Certificate mark



IP rating



Different light colours



Excellent thermal management



Excellent visual comfort



Fixed



Certificate mark



IP rating



Different light colours



Excellent thermal management



Excellent visual comfort





LIGHT EFFECT



General Lighting



Accent Lighting



Wall washing Lighting

Lattice

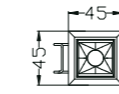
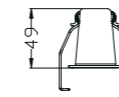

010180A-01

LED: OSRAM/CREE  
 Cutout: 37\*37mm  
 Input: 220~240V  
 Wattage: 2W  
 Beam Angle: 15°/30°/45°  
 CCT: 2700~5500K  
 RA: ≥90



37\*37mm



- 1 Non-Dim
- 2 0-10 V Dim
- 3 Triac dim
- 4 Dali dim
- 5 Mesh

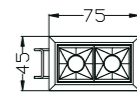
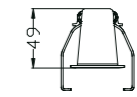

010180A-02

LED: OSRAM/CREE  
 Cutout: 68\*37mm  
 Input: 220~240V  
 Wattage: 4W  
 Beam Angle: 15°/30°/45°  
 CCT: 2700~5500K  
 RA: ≥90

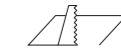

68\*37mm

FEATURES



tuya BLE Mesh app



Fixed



Certificate mark



IP rating



Different light distributions



Excellent thermal management



Excellent visual comfort

Lattice

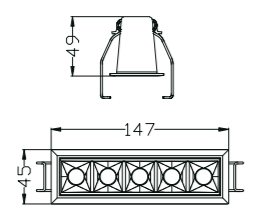

010180A-05

LED: OSRAM/CREE  
 Cutout: 140\*37mm  
 Input: 220~240V  
 Wattage: 10W  
 Beam Angle: 15°/30°/45°  
 CCT: 2700~5500K  
 RA: ≥90

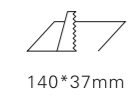

140\*37mm

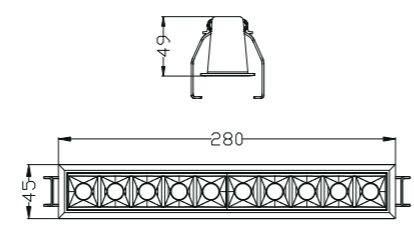
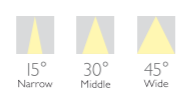

010180A-10

LED: OSRAM/CREE  
 Cutout: 273\*37mm  
 Input: 220~240V  
 Wattage: 20W  
 Beam Angle: 15°/30°/45°  
 CCT: 2700~5500K  
 RA: ≥90

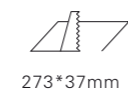

273\*37mm

Lattice

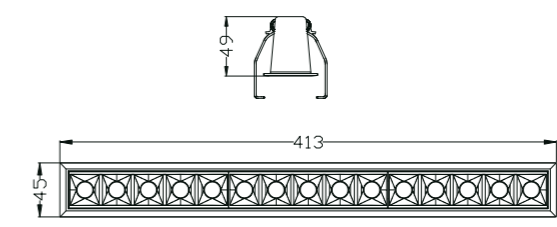

010180A-15

LED: OSRAM/CREE  
 Cutout: 405\*37mm  
 Input: 220~240V  
 Wattage: 30W  
 Beam Angle: 15°/30°/45°  
 CCT: 2700~5500K  
 RA: ≥90

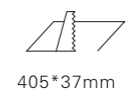

405\*37mm

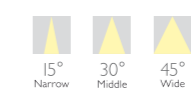

Fixed
 Certificate mark
 IP rating
 Different light distributions
 Excellent thermal management
 Excellent visual comfort

Fixed
 Certificate mark
 IP rating
 Different light distributions
 Excellent thermal management
 Excellent visual comfort





Lattice

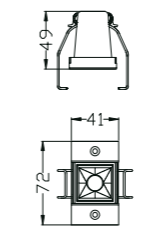

010180B-01

LED: OSRAM/CREE  
 Cutout: 41\*41mm  
 Input: 220~240V  
 Wattage: 2W  
 Beam Angle: 15°/30°/45°  
 CCT: 2700~5500K  
 RA: ≥90

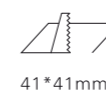

41\*41mm

- DIMMABLE
- 1 Non-Dim
  - 2 0-10 V Dim
  - 3 Triac dim
  - 4 Dali dim
  - 5 Mesh

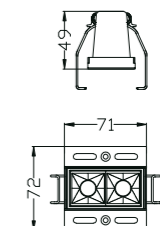

010180B-02

LED: OSRAM/CREE  
 Cutout: 72\*41mm  
 Input: 220~240V  
 Wattage: 4W  
 Beam Angle: 15°/30°/45°  
 CCT: 2700~5500K  
 RA: ≥90

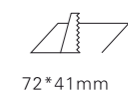

72\*41mm

FEATURES



tuya BLE Mesh app



Fixed



Certificate mark



IP rating



Different light distributions



Excellent thermal management



Excellent visual comfort

Lattice

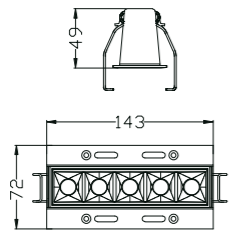

010180B-05

LED: OSRAM/CREE  
 Cutout: 144\*41mm  
 Input: 220~240V  
 Wattage: 10W  
 Beam Angle: 15°/30°/45°  
 CCT: 2700~5500K  
 RA: ≥90

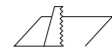

144\*41mm

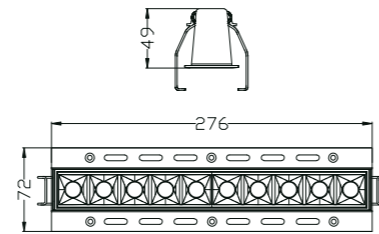
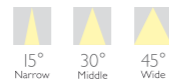

010180B-10

LED: OSRAM/CREE  
 Cutout: 277\*41mm  
 Input: 220~240V  
 Wattage: 20W  
 Beam Angle: 15°/30°/45°  
 CCT: 2700~5500K  
 RA: ≥90

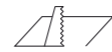

277\*41mm

Lattice

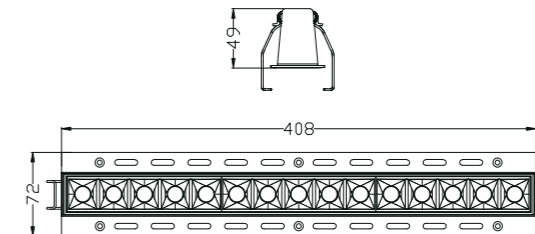

010180B-15

LED: OSRAM/CREE  
 Cutout: 410\*41mm  
 Input: 220~240V  
 Wattage: 30W  
 Beam Angle: 15°/30°/45°  
 CCT: 2700~5500K  
 RA: ≥90

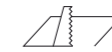

410\*41mm

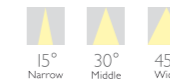

Fixed



Certificate mark



IP rating



Different light distributions



Excellent thermal management



Excellent visual comfort



Fixed



Certificate mark



IP rating



Different light distributions



Excellent thermal management



Excellent visual comfort





# LAITTE

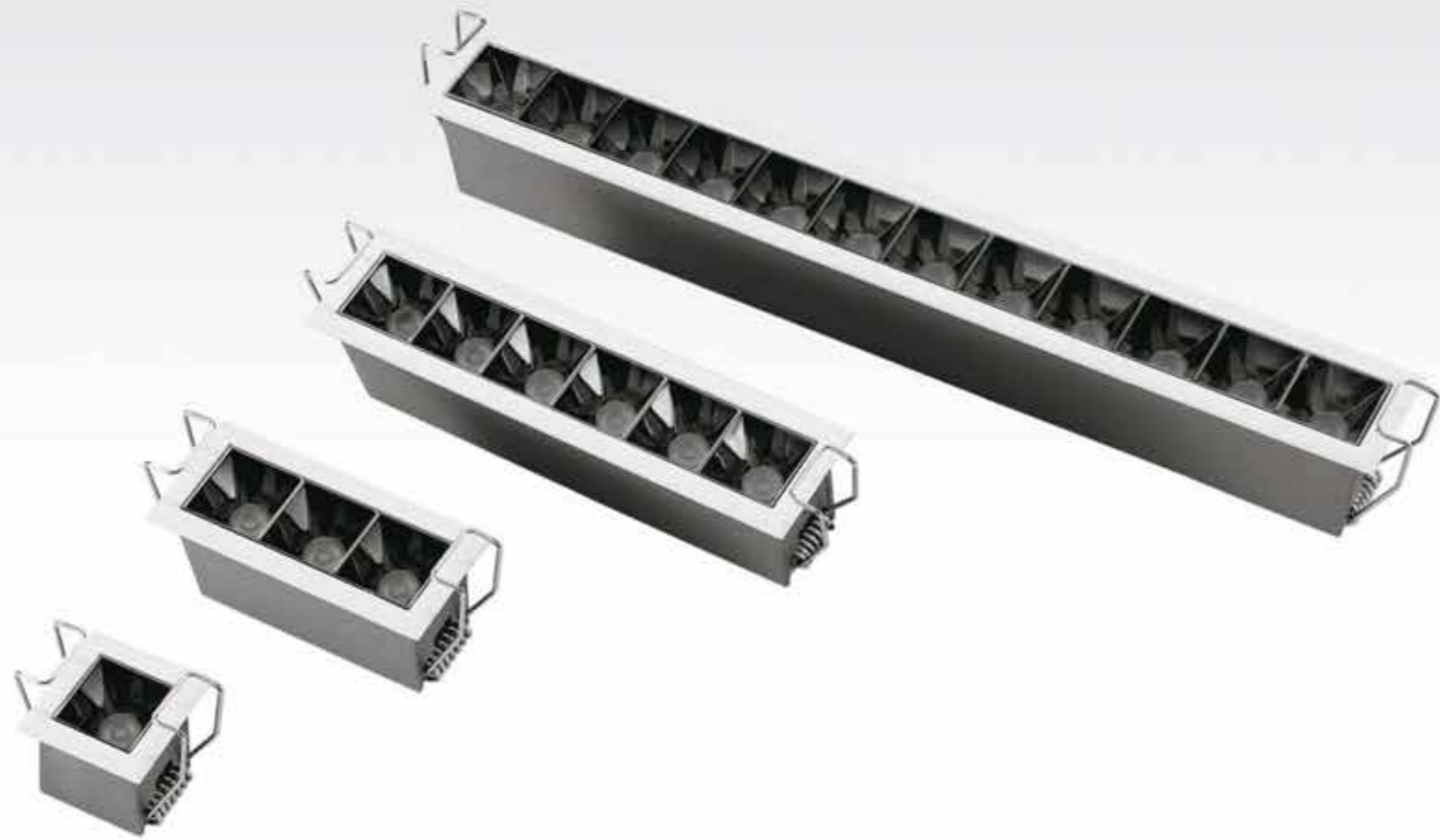

Lattice

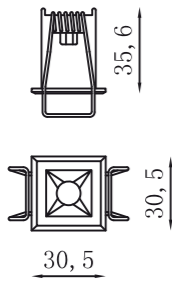

001Q-XTD01-WH

LED: OSRAM/CREE  
 Cutout: 26\*26mm  
 Input: 100~240V  
 Wattage: 2W  
 Beam Angle: 15°/24°/38°  
 CCT: 3000K~6000K  
 RA: ≥90

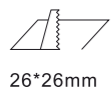

26\*26mm



- 1 Non-Dim
- 2 0-10 V Dim
- 3 Triac dim
- 4 Dali dim
- 5 Mesh

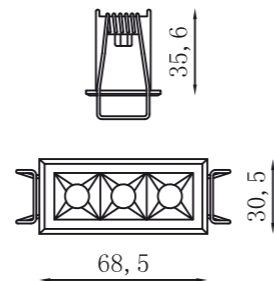

001Q-XTD03-WH

LED: OSRAM/CREE  
 Cutout: 64\*26mm  
 Input: 100~240V  
 Wattage: 4W  
 Beam Angle: 15°/24°/38°  
 CCT: 3000K~6000K  
 RA: ≥90

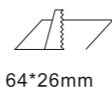

64\*26mm

FEATURES



tuya BLE Mesh app

Lattice

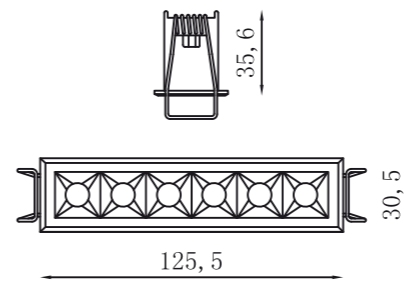

001Q-XTD06-WH

LED: OSRAM/CREE  
 Cutout: 121\*26mm  
 Input: 100~240V  
 Wattage: 8W  
 Beam Angle: 15°/24°/38°  
 CCT: 3000K~6000K  
 RA: ≥90

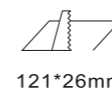

121\*26mm

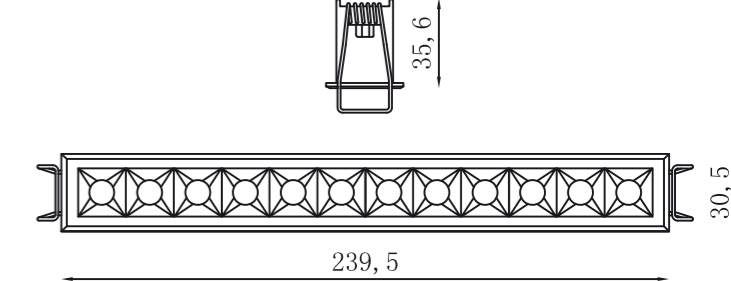

001Q-XTD12-WH

LED: OSRAM/CREE  
 Cutout: 235\*26mm  
 Input: 100~240V  
 Wattage: 15W  
 Beam Angle: 15°/24°/38°  
 CCT: 3000K~6000K  
 RA: ≥90

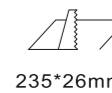

235\*26mm

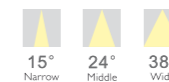

Fixed



Certificate mark



IP rating



Different light distributions



Excellent thermal management



Excellent visual comfort



Fixed



Certificate mark



IP rating



Different light distributions



Excellent thermal management



Excellent visual comfort



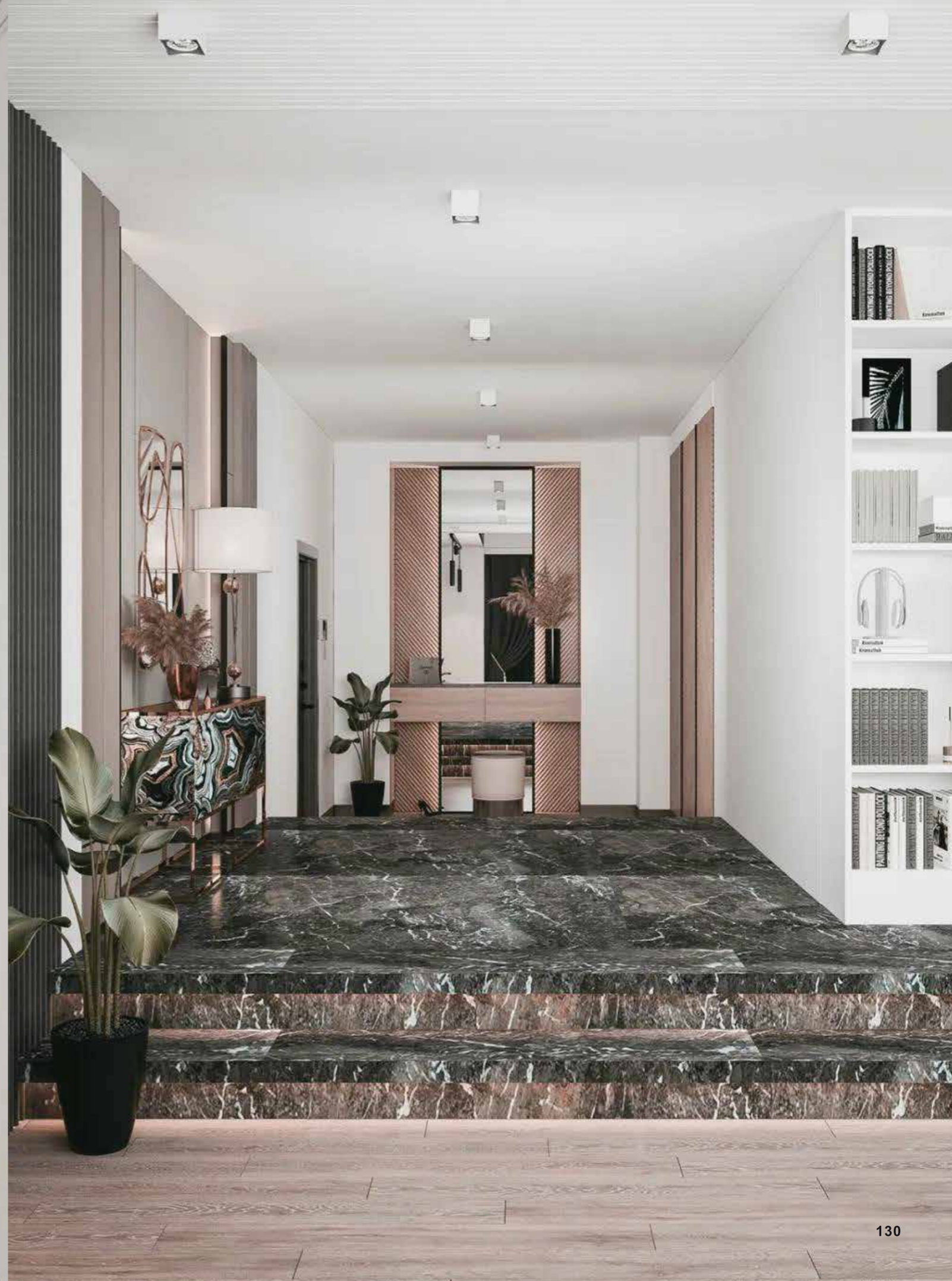



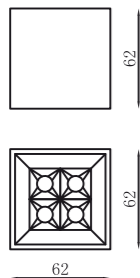

### 001M-XTD04-WH

Wattage: 5W  
 Voltage: 100-240VAC 50/60Hz  
 CCT: 3000K/4000K/5000K/6000K  
 Material: Die casting aluminum  
 Shielding angle: 31.8°  
 Beam Angle: 15°/24°/38°  
 Color: White/Black  
 Size: 62\*62\*62mm  
 Installation: Surface

- DIMMABLE**
- 1 Non-Dim
  - 2 0-10 V Dim
  - 3 Triac dim
  - 4 Dali dim
  - 5 Mesh

### Lattice

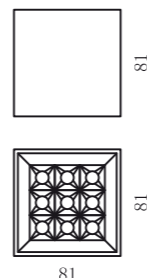

### 001M-XTD09-WH

Wattage: 10W  
 Voltage: 100-240VAC 50/60Hz  
 CCT: 3000K/4000K/5000K/6000K  
 Material: Die casting aluminum  
 Shielding angle: 31.8°  
 Beam Angle: 15°/24°/38°  
 Color: White/Black  
 Size: 81\*81\*81mm  
 Installation: Surface

### FEATURES

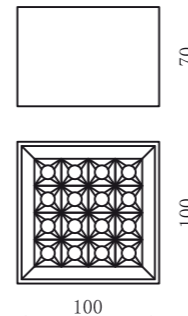

### 001M-XTD16-BK

Wattage: 16W  
 Voltage: 100-240VAC 50/60Hz  
 CCT: 3000K/4000K/5000K/6000K  
 Material: Die casting aluminum  
 Shielding angle: 31.8°  
 Beam Angle: 15°/24°/38°  
 Color: White/Black  
 Size: 100\*100\*70mm  
 Installation: Surface

### Lattice

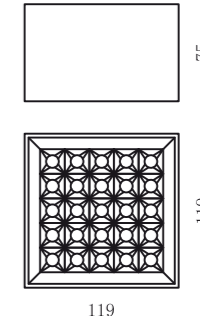

### 001M-XTD25-WH

Wattage: 25W  
 Voltage: 100-240VAC 50/60Hz  
 CCT: 3000K/4000K/5000K/6000K  
 Material: Die casting aluminum  
 Shielding angle: 31.8°  
 Beam Angle: 15°/24°/38°  
 Color: White/Black  
 Size: 119\*119\*75mm  
 Installation: Surface

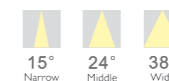



# Lattice Adjustable



Lattice Adjustable

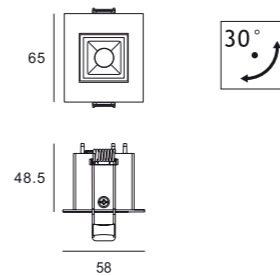

010180C01

LED: OSRAM  
 Cutout: 55x45mm  
 Input: 220~240VAC  
 Wattage: 2W  
 Beam Angle: 15°/30°/45°  
 CCT: 2700~5500K  
 RA: ≥90



55\*45mm

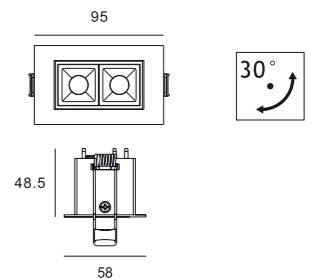

010180C02

LED: OSRAM  
 Cutout: 75x45mm  
 Input: 220~240VAC  
 Wattage: 4W  
 Beam Angle: 15°/30°/45°  
 CCT: 2700~5500K  
 RA: ≥90

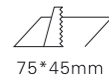

75\*45mm

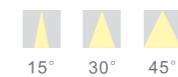

15° 30° 45°

- DIMMABLE
- 1 Non-Dim
  - 2 0-10 V Dim
  - 3 Triac dim
  - 4 Dali dim
  - 5 Mesh

### FEATURES



Adjustable



Certificate mark



IP rating



Different light distributions



Excellent thermal management

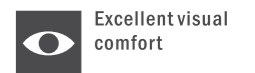

Excellent visual comfort



Lattice Adjustable

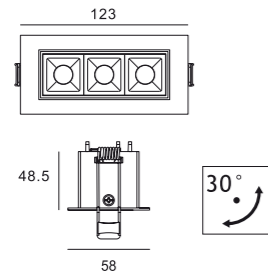

010180C03

LED: OSRAM  
 Cutout: 110x45mm  
 Input: 220~240VAC  
 Wattage: 6W  
 Beam Angle: 15°/30°/45°  
 CCT: 2700~5500K  
 RA: ≥90

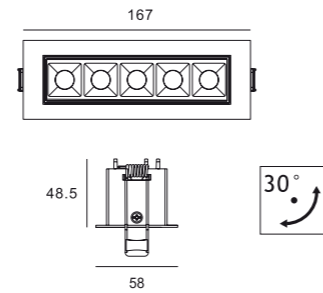
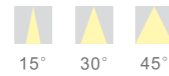
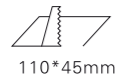

010180C04

LED: OSRAM  
 Cutout: 155x45mm  
 Input: 220~240VAC  
 Wattage: 10W  
 Beam Angle: 15°/30°/45°  
 CCT: 2700~5500K  
 RA: ≥90

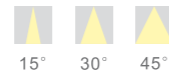
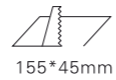

Lattice Adjustable

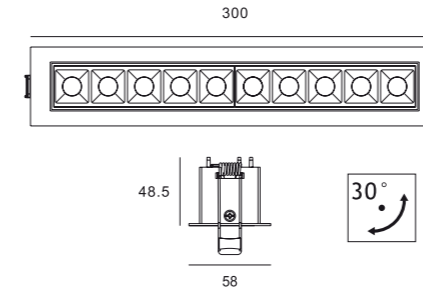

010180C10

LED: OSRAM  
 Cutout: 290x45mm  
 Input: 220~240VAC  
 Wattage: 20W  
 Beam Angle: 15°/30°/45°  
 CCT: 2700~5500K  
 RA: ≥90

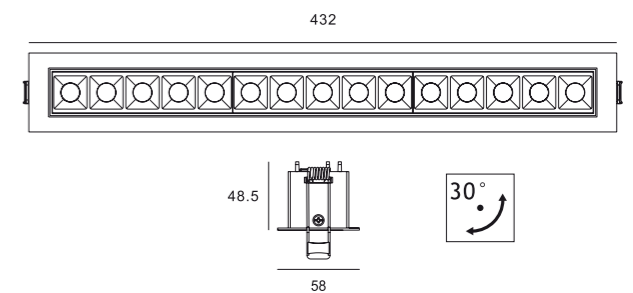
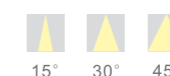

010180C15

LED: OSRAM  
 Cutout: 420x45mm  
 Input: 220~240VAC  
 Wattage: 30W  
 Beam Angle: 15°/30°/45°  
 CCT: 2700~5500K  
 RA: ≥90

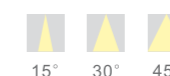
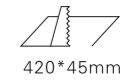

Adjustable



Certificate mark



IP rating



Different light distributions



Excellent thermal management



Excellent visual comfort



Adjustable



Certificate mark



IP rating



Different light distributions



Excellent thermal management



Excellent visual comfort



Lattice Ceiling

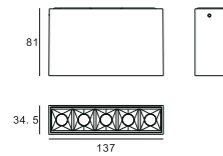

010180D05

LED: OSRAM/CREE  
 Cutout: 137x34.5x81mm  
 Input: 220~240VAC  
 Wattage: 10W  
 Beam Angle: 15°/30°/45°/wallwasher  
 CCT: 2700~5500K  
 RA: ≥90

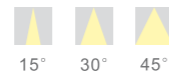

- 1 Non-Dim
- 2 0-10 V Dim
- 3 Triac dim
- 4 Dali dim
- 5 Mesh

FEATURES



Lattice Ceiling

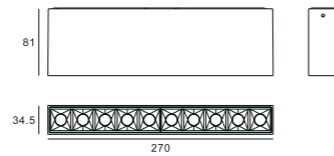

010180D10

LED: OSRAM/CREE  
 Cutout: 270x34.5x81mm  
 Input: 220~240VAC  
 Wattage: 20W  
 Beam Angle: 15°/30°/45°/wallwasher  
 CCT: 2700~5500K  
 RA: ≥90

Lattice Ceiling

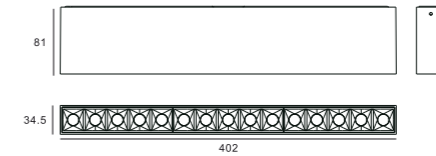

010180D15

LED: OSRAM/CREE  
 Cutout: 402x34.5x81mm  
 Input: 220~240VAC  
 Wattage: 30W  
 Beam Angle: 15°/30°/45°/wallwasher  
 CCT: 2700~5500K  
 RA: ≥90

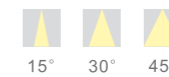



# Lattice Track



## Lattice Track

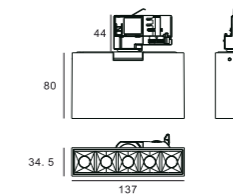

010180E05

LED: OSRAM/CREE  
 Cutout: 137+44x34.5x81mm  
 Input: 220~240VAC  
 Wattage: 10W  
 Beam Angle: 15°/30°/45°/wallwasher  
 CCT: 2700~5500K  
 RA: ≥90



- DIMMABLE
- 1 Non-Dim
  - 2 0-10 V Dim
  - 3 Triac dim
  - 4 Dali dim
  - 5 Mesh

### FEATURES



Adjustable



Certificate mark



IP rating



Easy installation



Excellent thermal management



Excellent visual comfort





Lattice Track

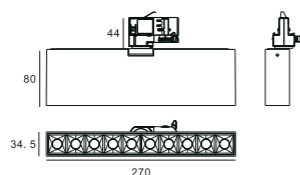

010180E10

LED: OSRAM/CREE  
Cutout: 270+44x34.5x81mm  
Input: 220~240VAC  
Wattage: 20W  
Beam Angle: 15°/30°/45°/wallwasher  
CCT: 2700~5500K  
RA: ≥90



Adjustable



Certificate mark



IP rating



Easy installation



Excellent thermal management



Excellent visual comfort



Lattice Track

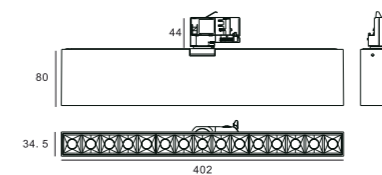

010180E15

LED: OSRAM/CREE  
Cutout: 402+44x34.5x81mm  
Input: 220~240VAC  
Wattage: 30W  
Beam Angle: 15°/30°/45°/wallwasher  
CCT: 2700~5500K  
RA: ≥90



Adjustable



Certificate mark



IP rating



Easy installation



Excellent thermal management



Excellent visual comfort

# Lattice



## Lattice

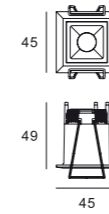

010181A01

LED: OSRAM/CREE  
 Cutout: 37x37mm  
 Input: 220~240VAC  
 Wattage: 2W  
 Beam Angle: 15°/30°/45°  
 CCT: 2700~5500K  
 RA: ≥90

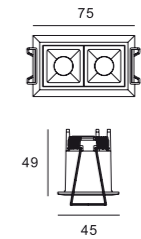
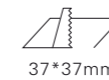

010181A02

LED: OSRAM/CREE  
 Cutout: 68x37mm  
 Input: 220~240VAC  
 Wattage: 4W  
 Beam Angle: 15°/30°/45°  
 CCT: 2700~5500K  
 RA: ≥90

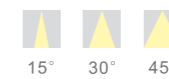
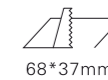

- DIMMABLE
- 1 Non-Dim
  - 2 0-10 V Dim
  - 3 Triac dim
  - 4 Dali dim
  - 5 Mesh

### FEATURES



Fixed



Certificate mark



IP rating

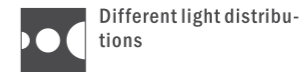

Different light distributions



Excellent thermal management

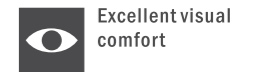

Excellent visual comfort

Lattice

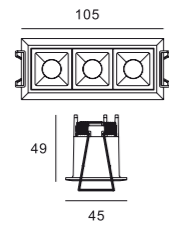

010181A03

LED: OSRAM/CREE  
Cutout: 100x37mm  
Input: 220~240VAC  
Wattage: 6W  
Beam Angle: 15°/30°/45°  
CCT: 2700~5500K  
RA: ≥90

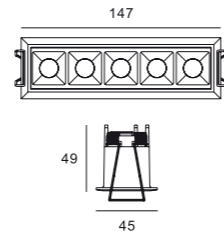
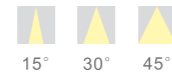
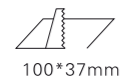

010181A05

LED: OSRAM/CREE  
Cutout: 140x37mm  
Input: 220~240VAC  
Wattage: 10W  
Beam Angle: 15°/30°/45°  
CCT: 2700~5500K  
RA: ≥90

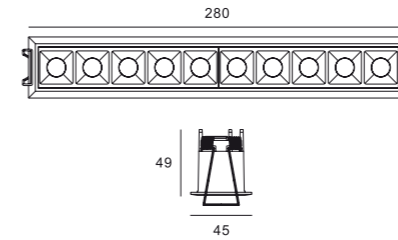
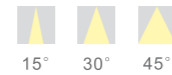
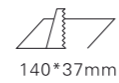

010181A10

LED: OSRAM/CREE  
Cutout: 237x37mm  
Input: 220~240VAC  
Wattage: 20W  
Beam Angle: 15°/30°/45°  
CCT: 2700~5500K  
RA: ≥90

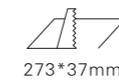

Lattice

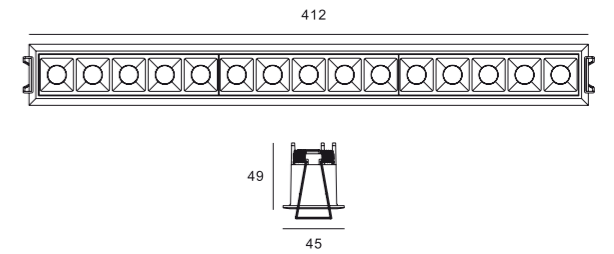

010181A15

LED: OSRAM/CREE  
Cutout: 405x37mm  
Input: 220~240VAC  
Wattage: 30W  
Beam Angle: 15°/30°/45°  
CCT: 2700~5500K  
RA: ≥90

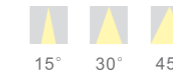
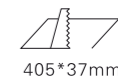

Fixed



Certificate mark



IP rating



Different light distributions



Excellent thermal management



Excellent visual comfort



Fixed



Certificate mark



IP rating



Different light distributions



Excellent thermal management



Excellent visual comfort

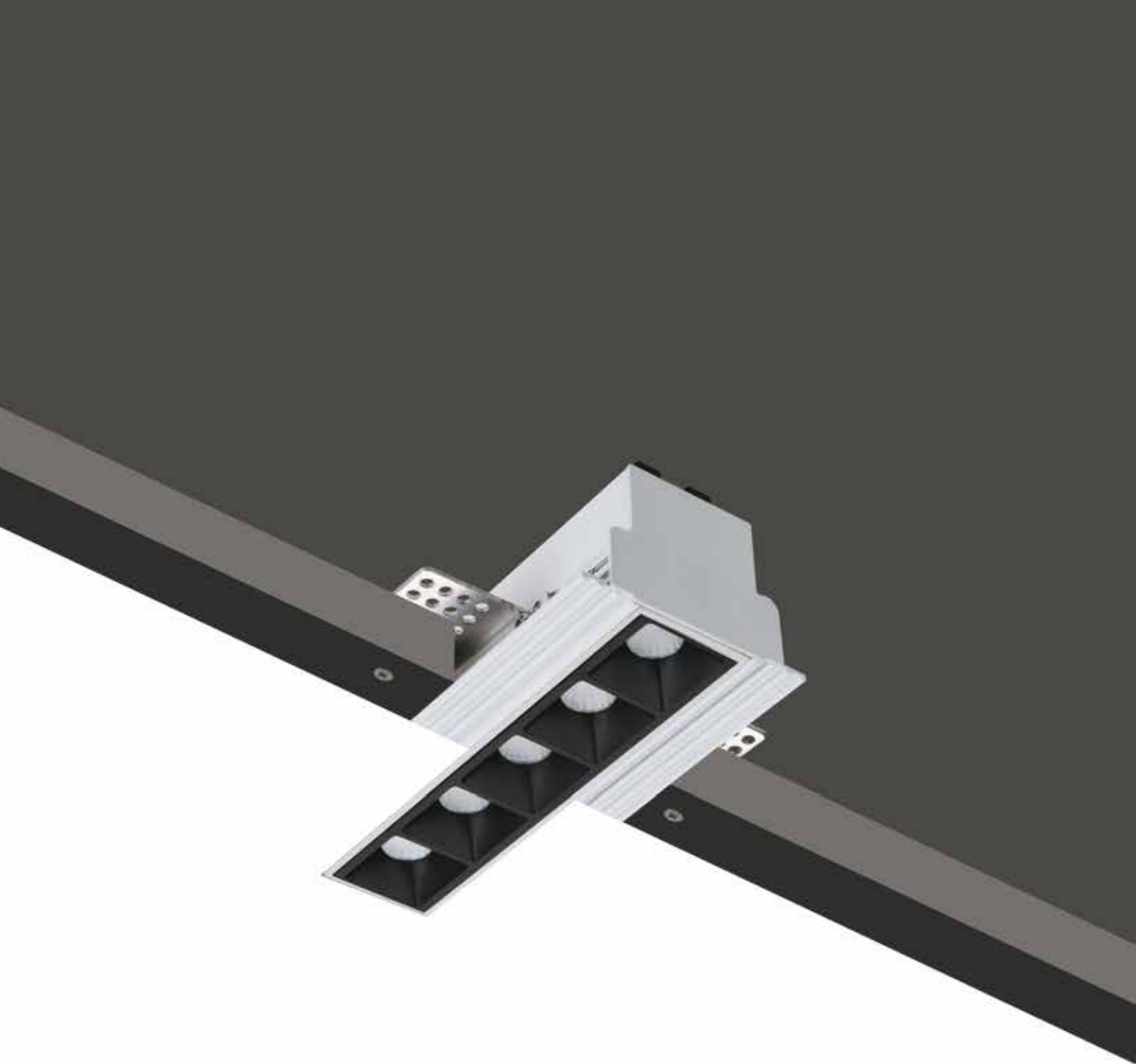

# Lattice Trimless

## Lattice Trimless

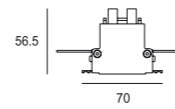
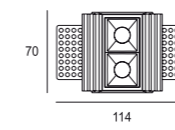

010181B02

LED: OSRAM/CREE  
 Cutout: 75x70mm  
 Input: 220~240VAC  
 Wattage: 4W  
 Beam Angle: 15°/30°/45°  
 CCT: 2700~5500K  
 RA: ≥90



75\*70mm

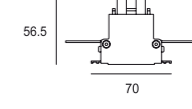
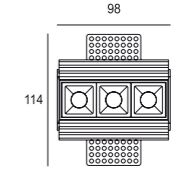

010181B03

LED: OSRAM/CREE  
 Cutout: 105x70mm  
 Input: 220~240VAC  
 Wattage: 6W  
 Beam Angle: 15°/30°/45°  
 CCT: 2700~5500K  
 RA: ≥90

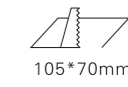

105\*70mm

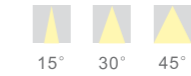

15° 30° 45°

- DIMMABLE
- 1 Non-Dim
  - 2 0-10 V Dim
  - 3 Triac dim
  - 4 Dali dim
  - 5 Mesh

### FEATURES



- Fixed
- Certificate mark
- IP rating
- Different light distributions
- Excellent thermal management
- Excellent visual comfort



Lattice Trimless

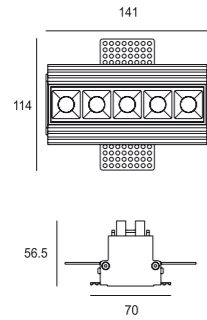

010181B05

LED: OSRAM/CREE  
 Cutout: 145x70mm  
 Input: 220~240VAC  
 Wattage: 10W  
 Beam Angle: 15°/30°/45°  
 CCT: 2700~5500K  
 RA: ≥90

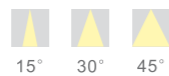
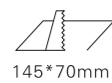

Lattice Trimless

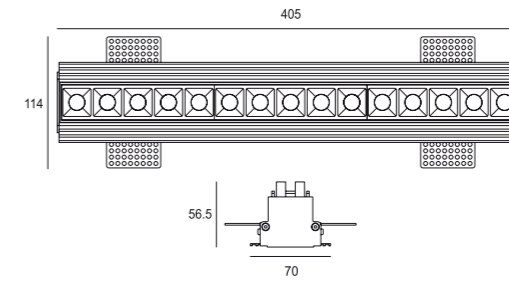

010181B15

LED: OSRAM/CREE  
 Cutout: 410x70mm  
 Input: 220~240VAC  
 Wattage: 30W  
 Beam Angle: 15°/30°/45°  
 CCT: 2700~5500K  
 RA: ≥90

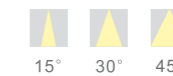
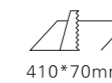

Lattice Tilt

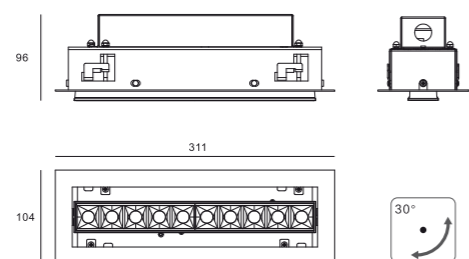

010181A10

LED: OSRAM  
 Cutout: 295x90mm  
 Input: 220~240VAC  
 Wattage: 20W  
 Beam Angle: 15°/30°/45°  
 CCT: 2700~5500K  
 RA: ≥90



295\*90mm



Adjustable



Certificate mark



IP rating



Different light distributions



Excellent thermal management



Excellent visual comfort

Lattice Tilt

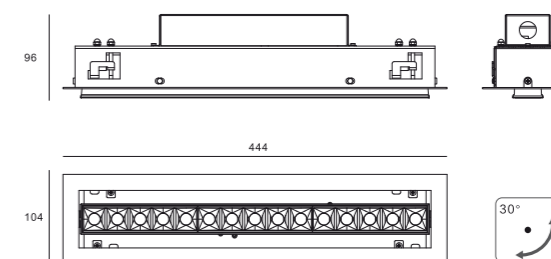

010009A15

LED: OSRAM  
 Cutout: 425x90mm  
 Input: 220~240VAC  
 Wattage: 30W  
 Beam Angle: 15°/30°/45°  
 CCT: 2700~5500K  
 RA: ≥90



425\*90mm



Adjustable



Certificate mark



IP rating



Different light distributions



Excellent thermal management



Excellent visual comfort

Lattice Tilt

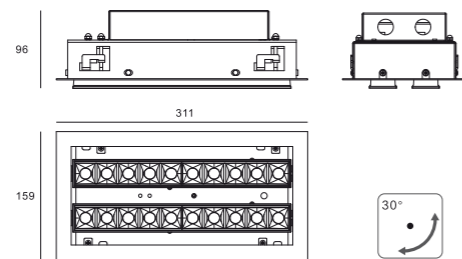

010009A20

LED: OSRAM  
 Cutout: 295x145mm  
 Input: 220~240VAC  
 Wattage: 2x20W  
 Beam Angle: 15°/30°/45°  
 CCT: 2700~5500K  
 RA: ≥90

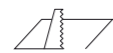

295\*145mm



Lattice Tilt

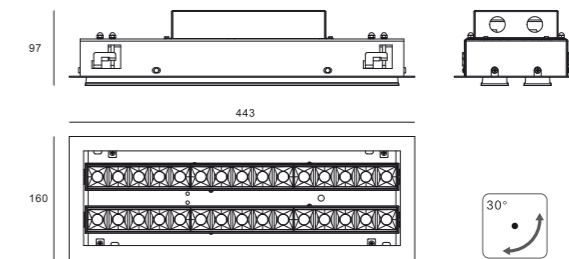

010009A30

LED: OSRAM  
 Cutout: 417x140mm  
 Input: 220~240VAC  
 Wattage: 2x30W  
 Beam Angle: 15°/30°/45°  
 CCT: 2700~5500K  
 RA: ≥90

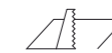

417\*140mm



Lattice L

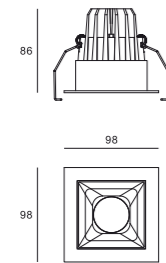

010011A01

LED: OSRAM/CREE/PHILIPS  
Cutout: 75x75mm  
Input: 220~240VAC  
Wattage: 10W  
Beam Angle: 15°/30°/45°  
CCT: 2700~5500K  
RA: ≥90

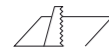

75\*75mm



Lattice L

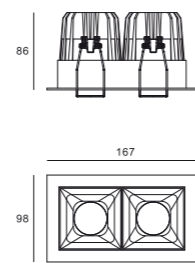

010011A02

LED: OSRAM/CREE/PHILIPS  
Cutout: 145x75mm  
Input: 220~240VAC  
Wattage: 20W  
Beam Angle: 15°/30°/45°  
CCT: 2700~5500K  
RA: ≥90

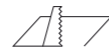

145\*75mm

Lattice L

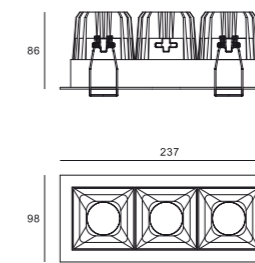

010011A03

LED: OSRAM/CREE/PHILIPS  
Cutout: 218x75mm  
Input: 220~240VAC  
Wattage: 20W  
Beam Angle: 15°/30°/45°  
CCT: 2700~5500K  
RA: ≥90

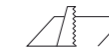

218\*75mm



Fixed



Certificate mark



IP rating



Different light distributions



Excellent thermal management



Excellent visual comfort



Fixed



Certificate mark



IP rating



Different light distributions



Excellent thermal management



Excellent visual comfort





Magic Cube

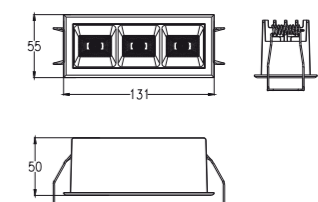
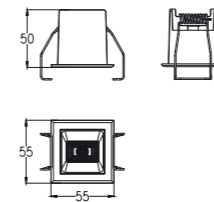

ROCA-XTD2-1

LED: CREE 5050-36V-5W  
 Size: 54\*54\*50mm  
 Installation: Recessed  
 Wattage: 4W  
 Beam Angle: 15°/24°/38°/50°  
 50°50°/70°70°/35°70°  
 Input: 200-240VAC 50/60Hz  
 RA: ≥90  
 Material: Die casting Alum.

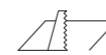

49°49mm



ROCA-XTD2-3

LED: CREE 5050-36V-5W  
 Size: 130\*54\*52mm  
 Installation: Recessed  
 Wattage: 12W  
 Beam Angle: 15°/24°/38°/50°  
 50°50°/70°70°/35°70°  
 Input: 200-240VAC 50/60Hz  
 RA: ≥90  
 Material: Die casting Alum.

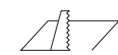

125°49mm



ROUND SPREAD LENS



RECTANGLE SPREAD LENS



SQUARE SPREAD LENS



DIMMABLE



Fixed



Certificate mark



IP rating

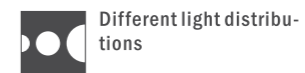

Different light distributions



Excellent thermal management

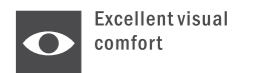

Excellent visual comfort

Magic Cube

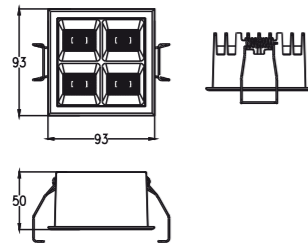

ROCA-XTD2-4

LED: CREE 5050-36V-5W  
 Size: 92\*92\*52mm  
 Installation: Recessed  
 Wattage: 15W  
 Beam Angle: 15°/24°/38°/50°  
 50°/50°/70°/70°/35°/70°  
 Input: 200-240VAC 50/60Hz  
 RA: ≥90  
 Material: Die casting Alum.

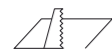

87\*87mm

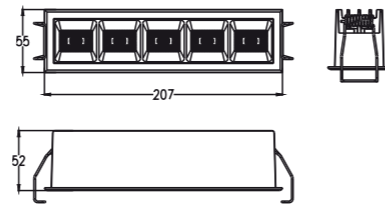

ROCA-XTD2-5

LED: CREE 5050-36V-5W  
 Size: 206\*54\*52mm  
 Installation: Recessed  
 Wattage: 20W  
 Beam Angle: 15°/24°/38°/50°  
 50°/50°/70°/70°/35°/70°  
 Input: 200-240VAC 50/60Hz  
 RA: ≥90  
 Material: Die casting Alum.

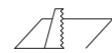

201\*49mm

Magic Cube

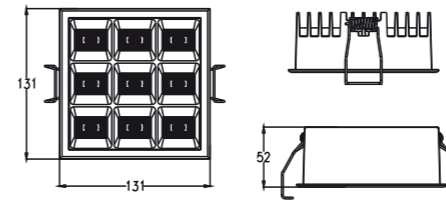

ROCA-XTD2-9

LED: CREE 5050-36V-5W  
 Size: 130\*130\*52mm  
 Installation: Recessed  
 Wattage: 36W  
 Beam Angle: 15°/24°/38°/50°  
 50°/50°/70°/70°/35°/70°  
 Input: 200-240VAC 50/60Hz  
 RA: ≥90  
 Material: Die casting Alum.

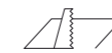

125\*125mm

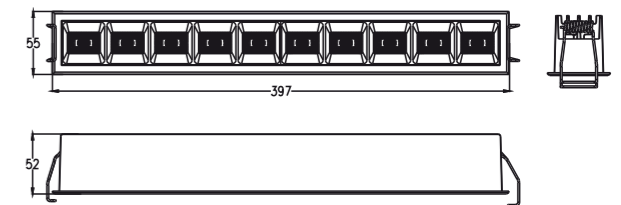

ROCA-XTD2-10

LED: CREE 5050-36V-5W  
 Size: 396\*54\*52mm  
 Installation: Recessed  
 Wattage: 40W  
 Beam Angle: 15°/24°/38°/50°  
 50°/50°/70°/70°/35°/70°  
 Input: 200-240VAC 50/60Hz  
 RA: ≥90  
 Material: Die casting Alum.

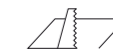

390\*49mm



Magic Cube



ROCA-MD006-4



ROCA-MD006-4

LED: CREE 5050-36V-5W  
Size: 82\*82\*80mm  
Installation: Surface Mounting  
Wattage: 15W  
Beam Angle: 27°/38°/55°  
Input: 200-240VAC 50/60Hz  
RA: ≥90  
Material: Die casting Alum.



Magic Cube



ROCA-MD006-9



ROCA-MD006-9

LED: CREE 5050-36V-5W  
Size: 120\*120\*90mm  
Installation: Surface Mounting  
Wattage: 40W  
Beam Angle: 27°/38°/55°  
Input: 200-240VAC 50/60Hz  
RA: ≥90  
Material: Die casting Alum.



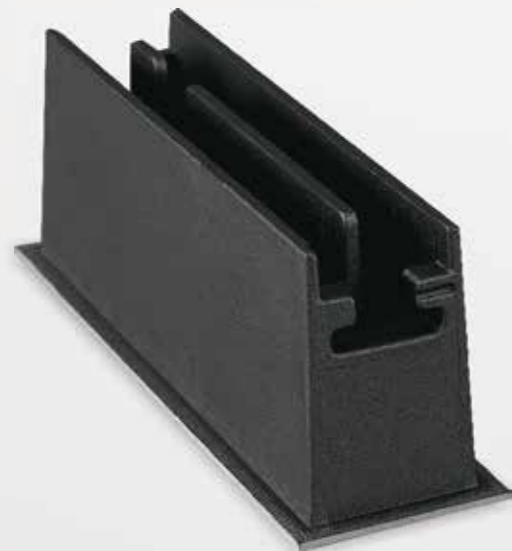

Lattice

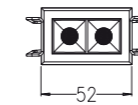
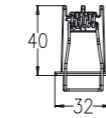

ROCA-XTD3-2

LED: OSRAM/CREE  
 Size: 48\*27.5mm  
 Input: 220V-240V  
 Wattage: 3W  
 Beam Angle: 30°/60°/30°/\*30°  
 CCT: 2700K~5500K  
 RA: 90

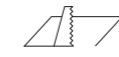

48\*27.5mm

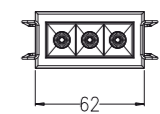
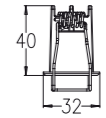
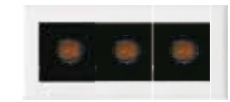

ROCA-XTD3-3

LED: OSRAM/CREE  
 Size: 57\*27.5mm  
 Input: 220V-240V  
 Wattage: 5W  
 Beam Angle: 30°/60°/30°/\*30°  
 CCT: 2700K~5500K  
 RA: 90

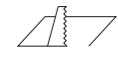

57\*27.5mm

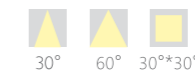

Fixed



Certificate mark



IP rating



Different light distributions



Excellent thermal management



Excellent visual comfort



Lattice

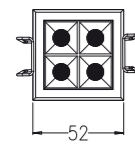
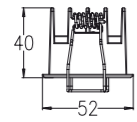
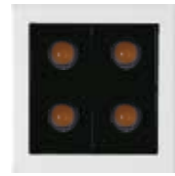

ROCA-XTD3-4

LED: OSRAM/CREE  
 Size: 48\*48mm  
 Input: 220V-240V  
 Wattage: 7W  
 Beam Angle: 30°/60°/30°/\*30°  
 CCT: 2700K~5500K  
 RA: 90

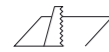

48\*48mm

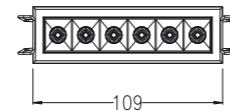
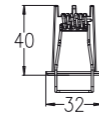
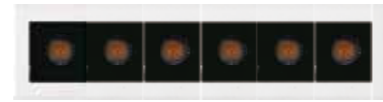
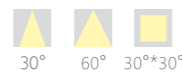

ROCA-XTD3-6

LED: OSRAM/CREE  
 Size: 104\*27.5mm  
 Input: 220V-240V  
 Wattage: 10W  
 Beam Angle: 30°/60°/30°/\*30°  
 CCT: 2700K~5500K  
 RA: 90

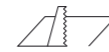

104\*27.5mm



Lattice

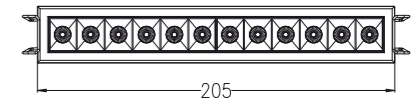
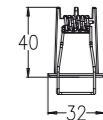
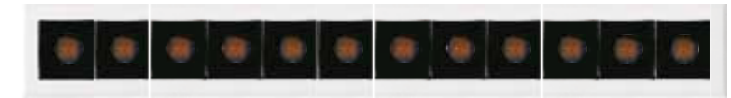

ROCA-XTD3-12

LED: OSRAM/CREE  
 Size: 200\*27.5mm  
 Input: 220V-240V  
 Wattage: 20W  
 Beam Angle: 30°/60°/30°/\*30°  
 CCT: 2700K~5500K  
 RA: 90

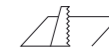

200\*27.5mm

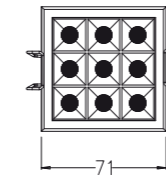
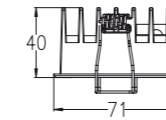
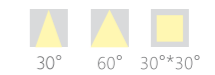

ROCA-XTD3-9

LED: OSRAM/CREE  
 Size: 68\*68mm  
 Input: 220V-240V  
 Wattage: 12W  
 Beam Angle: 30°/60°/30°/\*30°  
 CCT: 2700K~5500K  
 RA: 90



68\*68mm

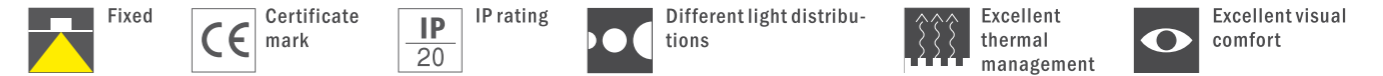



Lattice

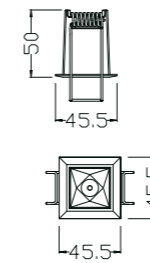

ROCA-XTD5-1

LED: OSRAM/CREE  
 Size: 40\*40mm  
 Input: 220V-240V  
 Wattage: 3W  
 Beam Angle: 12°/20°/34°/48°  
 CCT: 2700K~5500K  
 RA: 90

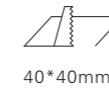

40\*40mm

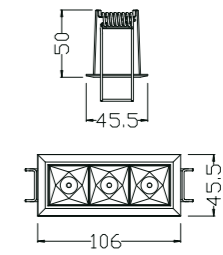
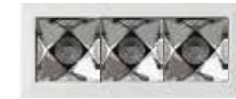

ROCA-XTD5-3

LED: OSRAM/CREE  
 Size: 100\*40mm  
 Input: 220V-240V  
 Wattage: 6W  
 Beam Angle: 12°/20°/34°/48°  
 CCT: 2700K~5500K  
 RA: 90

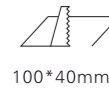

100\*40mm

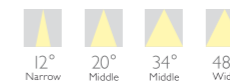

Fixed



Certificate mark



IP rating



Different light distributions



Excellent thermal management



Excellent visual comfort

Lattice

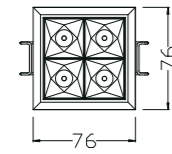
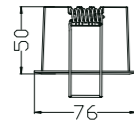

ROCA-XTD5-4

LED: OSRAM/CREE  
 Size: 70\*70mm  
 Input: 220V-240V  
 Wattage: 10W  
 Beam Angle: 12°/20°/34°/48°  
 CCT: 2700K~5500K  
 RA: 90

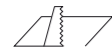

70\*70mm

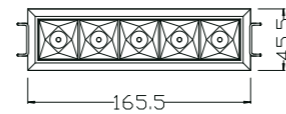
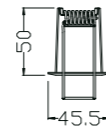
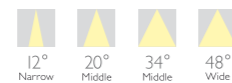

ROCA-XTD5-5

LED: OSRAM/CREE  
 Size: 160\*40mm  
 Input: 220V-240V  
 Wattage: 12W  
 Beam Angle: 12°/20°/34°/48°  
 CCT: 2700K~5500K  
 RA: 90

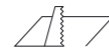

160\*40mm

Lattice

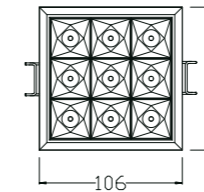
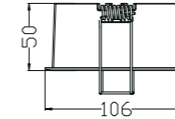
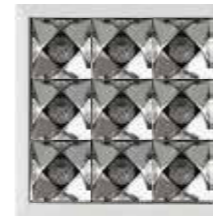

ROCA-XTD5-9

LED: OSRAM/CREE  
 Size: 100\*100mm  
 Input: 220V-240V  
 Wattage: 18W  
 Beam Angle: 12°/20°/34°/48°  
 CCT: 2700K~5500K  
 RA: 90

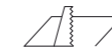

100\*100mm

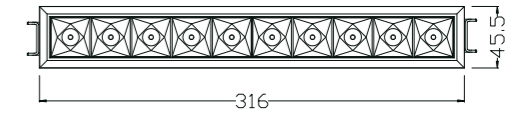
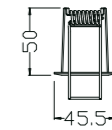
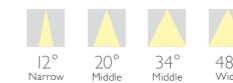

ROCA-XTD5-10

LED: OSRAM/CREE  
 Size: 310\*40mm  
 Input: 220V-240V  
 Wattage: 24W  
 Beam Angle: 12°/20°/34°/48°  
 CCT: 2700K~5500K  
 RA: 90

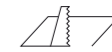

310\*40mm



Fixed



Certificate mark



IP rating



Different light distributions



Excellent thermal management



Excellent visual comfort



Fixed



Certificate mark



IP rating



Different light distributions



Excellent thermal management



Excellent visual comfort

Lattice

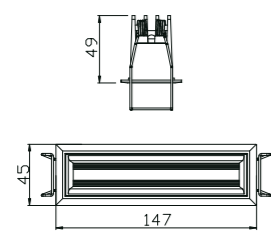

ROCA-XTD-XZ-05

LED: OSRAM/CREE  
Size: 140\*37mm  
Input: 220V-240V  
Wattage: 10W  
Beam Angle: 60°  
CCT: 2700K~5500K  
RA: 90

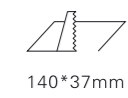

140\*37mm



Flood 60°

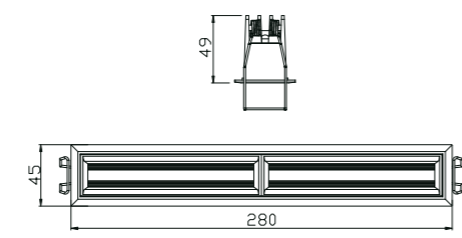

ROCA-XTD-XZ-10

LED: OSRAM/CREE  
Size: 273\*37mm  
Input: 220V-240V  
Wattage: 20W  
Beam Angle: 60°  
CCT: 2700K~5500K  
RA: 90

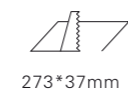

273\*37mm

Lattice

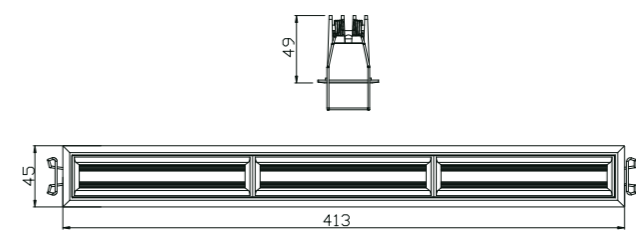

ROCA-XTD-XZ-15

LED: OSRAM/CREE  
Size: 405\*37mm  
Input: 220V-240V  
Wattage: 30W  
Beam Angle: 60°  
CCT: 2700K~5500K  
RA: 90

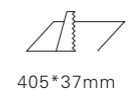

405\*37mm



Flood 60°

 Fixed
  Certificate mark
  IP rating
  Different light distributions
  Excellent thermal management
  Excellent visual comfort

 Fixed
  Certificate mark
  IP rating
  Different light distributions
  Excellent thermal management
  Excellent visual comfort



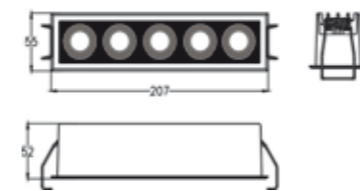

003Q-XTD05-WH

LED: CREE 5050-36V-5W  
 Size: 206\*54\*52mm  
 Installation: Recessed  
 Wattage: 20W  
 Beam Angle: 15°/24°/38°/50°  
 50°50°/70°70°/35°70°  
 Input: 100-240VAC 50/60Hz  
 RA: ≥90  
 Material: Die casting Alum.

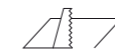

201\*49mm

- DIMMABLE
- 1 Non-Dim
  - 2 0-10 V Dim
  - 3 Triac dim
  - 4 Dali dim
  - 5 Mesh



Fixed



Certificate mark



IP rating



Different light distributions



Excellent thermal management



Excellent visual comfort

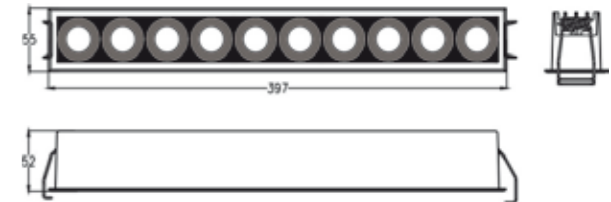

003Q-XTD10-WH

LED: CREE 5050-36V-5W  
 Size: 396\*54\*52mm  
 Installation: Recessed  
 Wattage: 40W  
 Beam Angle: 15°/24°/38°/50°  
 50°50°/70°70°/35°70°  
 Input: 100-240VAC 50/60Hz  
 RA: ≥90  
 Material: Die casting Alum.

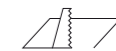

390\*49mm

FEATURES



tuya BLE Mesh app

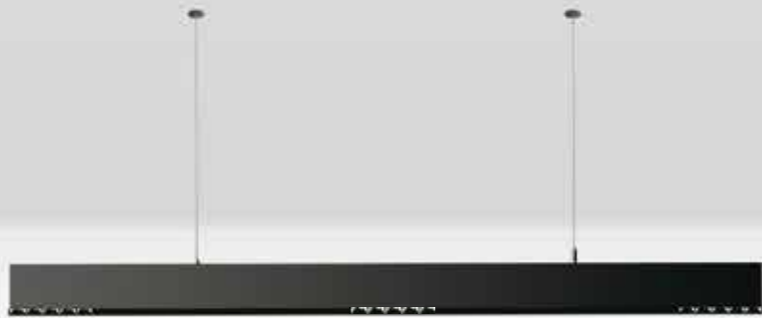

# Star

## Linear Surface/ Pendant

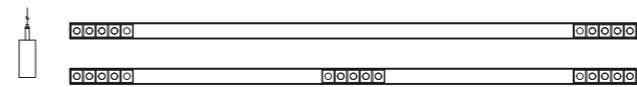

Code No.	Power	Beam angle	Color temperature	Light efficiency	LED Chip	CRI	SDCM	Size(mm)
ROCA3470-A	2×10W	15°/30°/45°	2700K/3000K/3500K/4000K	>70lm/W	OSRAM	>90	<5	L1196.5*W34*H70mm
ROCA3470-A	3×10W	15°/30°/45°	2700K/3000K/3500K/4000K	>70lm/W	OSRAM	>90	<5	L1196.5*W34*H70mm



Code No.	Power	Beam angle	Color temperature	Light efficiency	LED Chip	CRI	SDCM	Size(mm)
ROCA3470-B	40W	15°/30°/45°	2700K/3000K/3500K/4000K	>70lm/W	OSRAM	>90	<5	L1196.5*W34*H70mm



Code No.	Power	Diffuser	Color temperature	Light efficiency	LED Chip	CRI	SDCM	Size(mm)
ROCA3470-C	40W	PC	2700K/3000K/3500K/4000K	>70lm/W	OSRAM	>90	<5	L1196.5*W34*H70mm

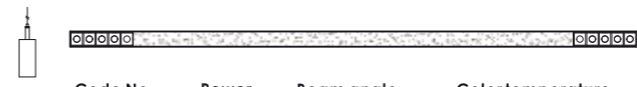

Code No.	Power	Beam angle	Color temperature	Light efficiency	LED Chip	CRI	SDCM	Size(mm)
ROCA3470-D	40W	15°/30°/45°	2700K/3000K/3500K/4000K	>70lm/W	OSRAM	>90	<5	L1196.5*W34*H70mm



Dimmable



Certificate mark



IP rating



Different light colours



Excellent thermal management



Excellent visual comfort



# Super linear

## Pendant



Code No.	Power	Color temperature	Light efficiency	LED Chip	CRI	SDCM	Size(mm)
ROCA3471-A	36W	2700K/3000K/3500K/4000K	>70lm/W	REFINE	>90	<5	L1204*W16*H65mm



Code No.	Power	Color temperature	Light efficiency	LED Chip	CRI	SDCM	Size(mm)
ROCA3471-B	24W+36W	2700K/3000K/3500K/4000K	>70lm/W	REFINE	>90	<5	L1204*W16*H65mm



Code No.	Power	Color temperature	Light efficiency	LED Chip	CRI	SDCM	Size(mm)
ROCA3471-C	36W	2700K/3000K/3500K/4000K	>70lm/W	REFINE	>90	<5	L1204*W16*H65mm



Code No.	Power	Color temperature	Light efficiency	LED Chip	CRI	SDCM	Size(mm)
ROCA3471-D	24W+36W	2700K/3000K/3500K/4000K	>70lm/W	REFINE	>90	<5	L1204*W16*H65mm



Code No.	Power	Color temperature	Light efficiency	LED Chip	CRI	SDCM	Size(mm)
ROCA3471-E	24W	2700K/3000K/3500K/4000K	>70lm/W	REFINE	>90	<5	L1204*W16*H65mm



Code No.	Power	Color temperature	Light efficiency	LED Chip	CRI	SDCM	Size(mm)
ROCA3471-F	36W	2700K/3000K/3500K/4000K	>70lm/W	REFINE	>90	<5	L1204*W16*H65mm



Code No.	Power	Color temperature	Light efficiency	LED Chip	CRI	SDCM	Size(mm)
ROCA3471-G	24W+36W	2700K/3000K/3500K/4000K	>70lm/W	REFINE	>90	<5	L1204*W16*H65mm



Dimmable



Certificate mark



IP rating



Different light colours



Excellent thermal management



Excellent visual comfort







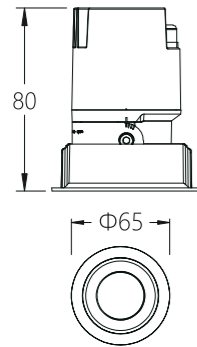

ROCASDF-R60

LED: LUMINUS/CITIZEN/CREE  
 Cutout:  $\Phi$ 60mm  
 Input: 220V-240V  
 Wattage: 6-8W  
 Beam Angle: 18°/24°/36°  
 CCT: 2700~5500K  
 RA: 90

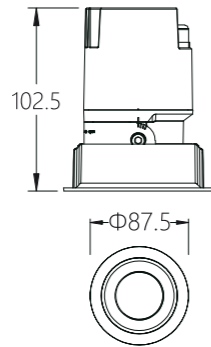

ROCASDF-R80

LED: LUMINUS/CITIZEN/CREE  
 Cutout:  $\Phi$ 80mm  
 Input: 220V-240V  
 Wattage: 9-12W  
 Beam Angle: 18°/24°/36°  
 CCT: 2700~5500K  
 RA: 90

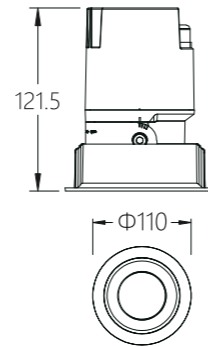

ROCASDF-R100

LED: LUMINUS/CITIZEN/CREE  
 Cutout:  $\Phi$ 100mm  
 Input: 220V-240V  
 Wattage: 15-20W  
 Beam Angle: 18°/24°/36°  
 CCT: 2700~5500K  
 RA: 90

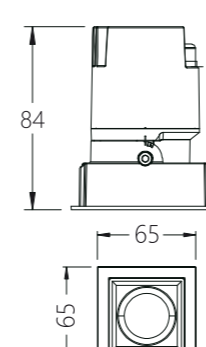

ROCASDF-R60

LED: LUMINUS/CITIZEN/CREE  
 Cutout: 60\*60mm  
 Input: 220V-240V  
 Wattage: 6-8W  
 Beam Angle: 18°/24°/36°  
 CCT: 2700~5500K  
 RA: 90

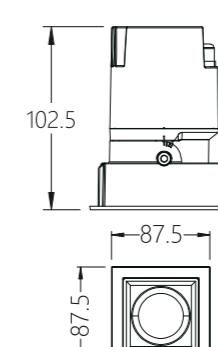
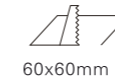

ROCASDF-R80

LED: LUMINUS/CITIZEN/CREE  
 Cutout: 80\*80mm  
 Input: 220V-240V  
 Wattage: 9-12W  
 Beam Angle: 18°/24°/36°  
 CCT: 2700~5500K  
 RA: 90

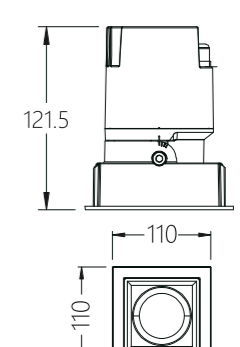
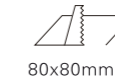

ROCASDF-R100

LED: LUMINUS/CITIZEN/CREE  
 Cutout: 100\*100mm  
 Input: 220V-240V  
 Wattage: 15-20W  
 Beam Angle: 18°/24°/36°  
 CCT: 2700~5500K  
 RA: 90

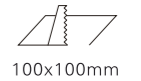

DIMMABLE

- 1 Non-Dim
- 2 0-10 V Dim
- 3 Triac dim
- 4 Dali dim
- 5 Mesh

FEATURES



Fixed



Certificate mark



IP rating



Different light colours



Excellent thermal management



Excellent visual comfort



Fixed



Certificate mark



IP rating



Different light colours



Excellent thermal management



Excellent visual comfort

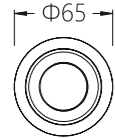
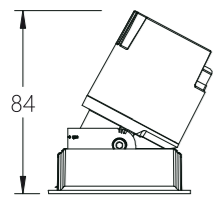

**ROCASDA-R60**

LED: LUMINUS/CITIZEN/CREE  
 Cutout:  $\Phi$ 60mm  
 Input: 220V-240V  
 Wattage: 6-8W  
 Beam Angle: 18°/24°/36°  
 CCT: 2700~5500K  
 RA: 90

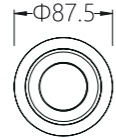
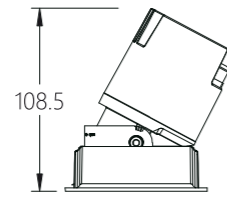

**ROCASDA-R80**

LED: LUMINUS/CITIZEN/CREE  
 Cutout:  $\Phi$ 80mm  
 Input: 220V-240V  
 Wattage: 9-12W  
 Beam Angle: 18°/24°/36°  
 CCT: 2700~5500K  
 RA: 90

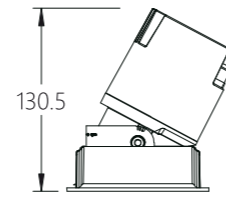

**ROCASDA-R100**

LED: LUMINUS/CITIZEN/CREE  
 Cutout:  $\Phi$ 100mm  
 Input: 220V-240V  
 Wattage: 15-20W  
 Beam Angle: 18°/24°/36°  
 CCT: 2700~5500K  
 RA: 90

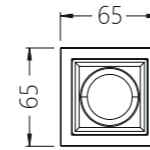
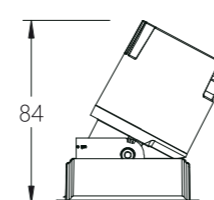

**ROCASDA-S60**

LED: LUMINUS/CITIZEN/CREE  
 Cutout: 60\*60mm  
 Input: 220V-240V  
 Wattage: 6-8W  
 Beam Angle: 18°/24°/36°  
 CCT: 2700~5500K  
 RA: 90

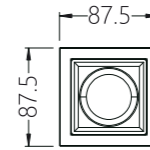
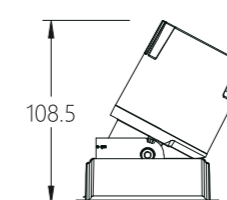
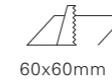

**ROCASDA-S80**

LED: LUMINUS/CITIZEN/CREE  
 Cutout: 80\*80mm  
 Input: 220V-240V  
 Wattage: 9-12W  
 Beam Angle: 18°/24°/36°  
 CCT: 2700~5500K  
 RA: 90

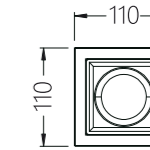
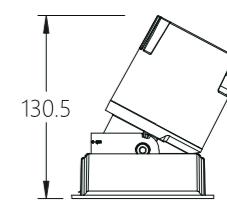

**ROCASDA-S100**

LED: LUMINUS/CITIZEN/CREE  
 Cutout: 100\*100mm  
 Input: 220V-240V  
 Wattage: 15-20W  
 Beam Angle: 18°/24°/36°  
 CCT: 2700~5500K  
 RA: 90

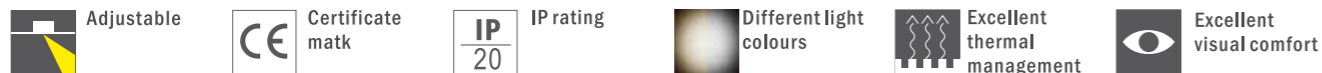
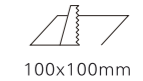

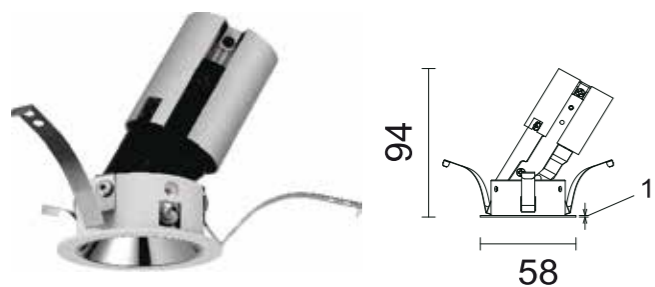

ROCASD50A-5

LED: LUMINUS/CITIZEN/CREE  
 Cutout:  $\Phi$ 50mm  
 Input: 220V-240V  
 Wattage: 5W  
 Beam Angle: 18°/24°/36°  
 CCT: 2700~5500K  
 RA: 90



$\Phi$ :50mm

- DIMMABLE
- 1 Non-Dim
  - 2 0-10 V Dim
  - 3 Triac dim
  - 4 Dali dim
  - 5 Mesh

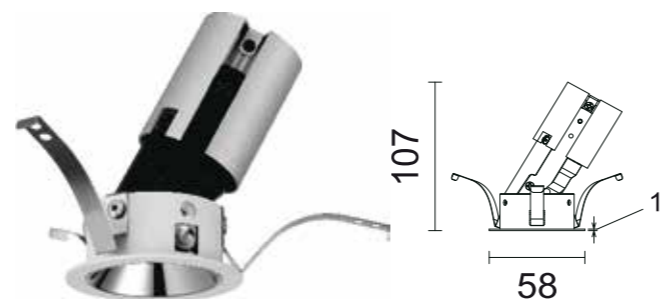

ROCASD50A-8

LED: LUMINUS/CITIZEN/CREE  
 Cutout:  $\Phi$ 50mm  
 Input: 220V-240V  
 Wattage: 8W  
 Beam Angle: 18°/24°/36°  
 CCT: 2700~5500K  
 RA: 90



$\Phi$ :50mm

FEATURES



Adjustable



Certificate mark



IP rating



Different light colours



Excellent thermal management

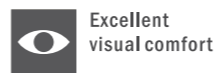

Excellent visual comfort

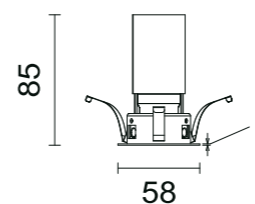

ROCASD50F-5

LED: LUMINUS/CITIZEN/CREE  
 Cutout:  $\Phi$ 50mm  
 Input: 220V-240V  
 Wattage: 5W  
 Beam Angle: 18°/24°/36°  
 CCT: 2700~5500K  
 RA: 90



$\Phi$ :50mm

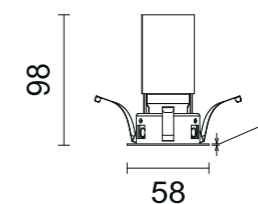

ROCASD50F-8

LED: LUMINUS/CITIZEN/CREE  
 Cutout:  $\Phi$ 50mm  
 Input: 220V-240V  
 Wattage: 8W  
 Beam Angle: 18°/24°/36°  
 CCT: 2700~5500K  
 RA: 90



$\Phi$ :50mm

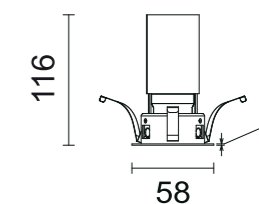

ROCASD50F-12

LED: LUMINUS/CITIZEN/CREE  
 Cutout:  $\Phi$ 50mm  
 Input: 220V-240V  
 Wattage: 12W  
 Beam Angle: 18°/24°/36°  
 CCT: 2700~5500K  
 RA: 90



$\Phi$ :50mm



CH



Fixed



Certificate mark



IP rating



Different light distributions



Excellent thermal management



Excellent visual comfort





Telescopic Spot Lights

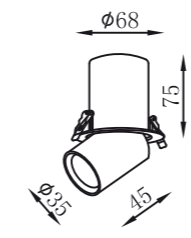

ROCA06055

LED: CITIZEN/CREE  
 Cutout:  $\Phi 55\text{mm}$   
 Input: 220V~240VAC  
 Wattage: 6W  
 Beam Angle: 15°/24°/36°  
 Color: Sand white/black  
 CCT: 2700~5500K  
 RA:  $\geq 90$



- DIMMABLE
- 1 Non-Dim
  - 2 0-10 V Dim
  - 3 Triac dim
  - 4 Dali dim
  - 5 Mesh

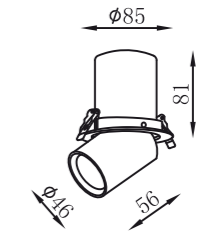

ROCA09075

LED: CITIZEN/CREE  
 Cutout:  $\Phi 75\text{mm}$   
 Input: 220V~240VAC  
 Wattage: 9W  
 Beam Angle: 15°/24°/36°  
 Color: Sand white/black  
 CCT: 2700~5500K  
 RA:  $\geq 90$

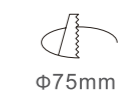

FEATURES



Adjustable



Certificate mark



IP rating



Different light colours



Excellent thermal management



Excellent visual comfort



Telescopic Spot Lights

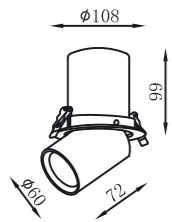

ROCA15095

LED: CITIZEN/CREE  
 Cutout:  $\Phi$ 95mm  
 Input: 220V~240VAC  
 Wattage: 15W  
 Beam Angle: 15°/24°/36°  
 Color: Sand white/black  
 CCT: 2700~5500K  
 RA:  $\geq$ 90

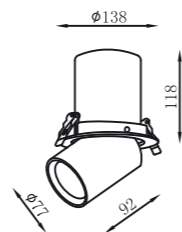
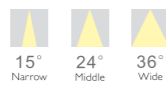

ROCA25120

LED: CITIZEN/CREE  
 Cutout:  $\Phi$ 120mm  
 Input: 220V~240VAC  
 Wattage: 25W  
 Beam Angle: 15°/24°/36°  
 Color: Sand white/black  
 CCT: 2700~5500K  
 RA:  $\geq$ 90



Telescopic Spot Lights

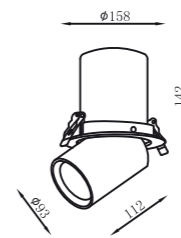

ROCA35140

LED: CITIZEN/CREE  
 Cutout:  $\Phi$ 145mm  
 Input: 220V~240VAC  
 Wattage: 35W  
 Beam Angle: 15°/24°/36°  
 Color: Sand white/black  
 CCT: 2700~5500K  
 RA:  $\geq$ 90

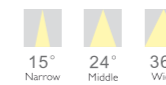

Adjustable



Certificate mark



IP rating



Different light colours



Excellent thermal management



Excellent visual comfort



Adjustable



Certificate mark



IP rating



Different light colours



Excellent thermal management



Excellent visual comfort



Down Light

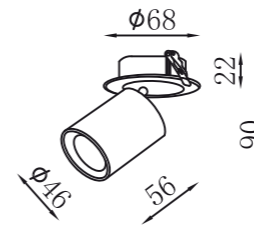

**ROCAM06055**

LED: CITIZEN/CREE  
 Cutout:  $\Phi 55\text{mm}$   
 Input: 220V~240VAC  
 Wattage: 6W  
 Beam Angle: 15°/24°/50°  
 Color: Sand white/black  
 CCT: 2700~5500K  
 RA:  $\geq 90$



- DIMMABLE
- 1 Non-Dim
  - 2 0-10 V Dim
  - 3 Triac dim
  - 4 Dali dim
  - 5 Mesh

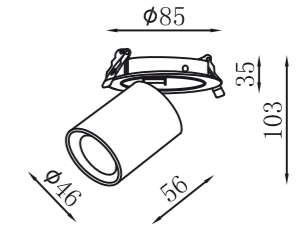

**ROCAM09075**

LED: CITIZEN/CREE  
 Cutout:  $\Phi 75\text{mm}$   
 Input: 220V~240VAC  
 Wattage: 9W  
 Beam Angle: 15°/24°/50°  
 Color: Sand white/black  
 CCT: 2700~5500K  
 RA:  $\geq 90$



FEATURES



Adjustable



Certificate mark



IP rating



Different light colours



Excellent thermal management



Excellent visual comfort

Down Light

Down Light

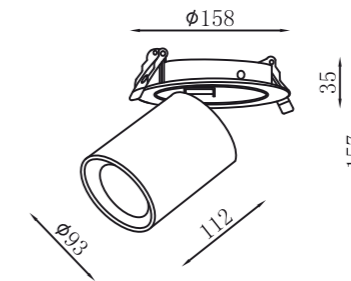
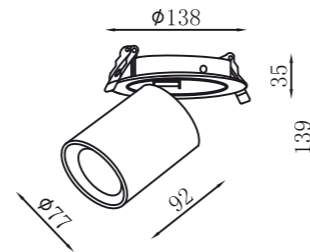
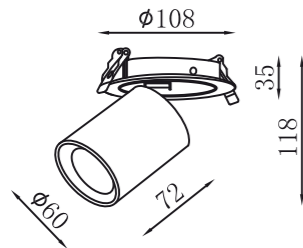

### ROCAM15095

### ROCAM25120

### ROCAM35140

LED: CITIZEN/CREE  
 Cutout:  $\Phi 95\text{mm}$   
 Input: 220V~240VAC  
 Wattage: 15W  
 Beam Angle: 15°/24°/36°  
 Color: Sand white/black  
 CCT: 2700~5500K  
 RA:  $\geq 90$

LED: CITIZEN/CREE  
 Cutout:  $\Phi 120\text{mm}$   
 Input: 220V~240VAC  
 Wattage: 25W  
 Beam Angle: 15°/24°/36°  
 Color: Sand white/black  
 CCT: 2700~5500K  
 RA:  $\geq 90$

LED: CITIZEN/CREE  
 Cutout:  $\Phi 145\text{mm}$   
 Input: 220V~240VAC  
 Wattage: 35W  
 Beam Angle: 15°/24°/36°  
 Color: Sand white/black  
 CCT: 2700~5500K  
 RA:  $\geq 90$

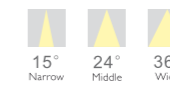
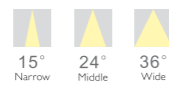

Adjustable



Certificate mark



IP rating



Different light colours



Excellent thermal management



Excellent visual comfort



Adjustable



Certificate mark



IP rating



Different light colours



Excellent thermal management



Excellent visual comfort



Smart S





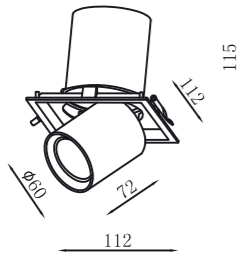

**ROCA9595**

LED: CITIZEN/CREE  
 Cutout: 95x95mm  
 Input: 220V~240VAC  
 Wattage: 1x15W  
 Beam Angle: 15°/24°/36°  
 Color: Sand white/black  
 CCT: 2700~5500K  
 RA: ≥90

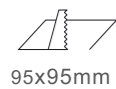

- DIMMABLE
- 1 Non-Dim
  - 2 0-10 V Dim
  - 3 Triac dim
  - 4 Dali dim
  - 5 Mesh

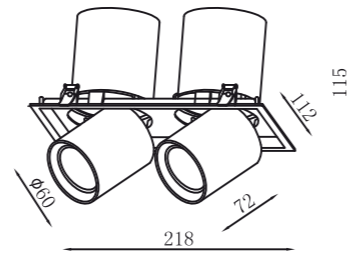

**ROCA95195**

LED: CITIZEN/CREE  
 Cutout: 95x195mm  
 Input: 220V~240VAC  
 Wattage: 2x15W  
 Beam Angle: 15°/24°/36°  
 Color: Sand white/black  
 CCT: 2700~5500K  
 RA: ≥90

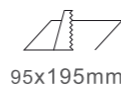

**FEATURES**

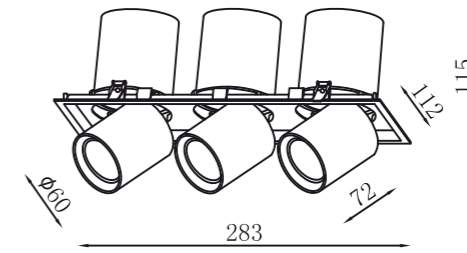

**ROCA95265**

LED: CITIZEN/CREE  
 Cutout: 95x265mm  
 Input: 220V~240VAC  
 Wattage: 3x15W  
 Beam Angle: 15°/24°/36°  
 Color: Sand white/black  
 CCT: 2700~5500K  
 RA: ≥90

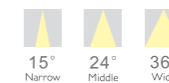
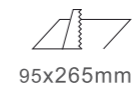

Adjustable



Certificate mark



IP rating



Different light colours



Excellent thermal management



Excellent visual comfort



Adjustable



Certificate mark



IP rating



Different light colours



Excellent thermal management



Excellent visual comfort

Grille Light

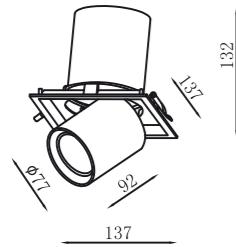

ROCA120120

LED: CITIZEN/CREE  
 Cutout: 120x120mm  
 Input: 220V~240VAC  
 Wattage: 1x25W  
 Beam Angle: 15°/24°/36°  
 Color: Sand white/black  
 CCT: 2700~5500K  
 RA: ≥90

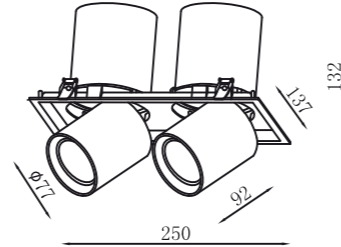
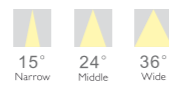
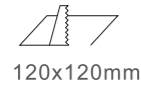

ROCA120235

LED: CITIZEN/CREE  
 Cutout: 120x235mm  
 Input: 220V~240VAC  
 Wattage: 2x25W  
 Beam Angle: 15°/24°/36°  
 Color: Sand white/black  
 CCT: 2700~5500K  
 RA: ≥90

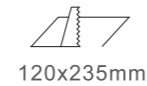

Grille Light

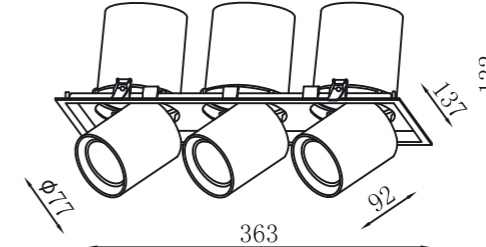

ROCA120345

LED: CITIZEN/CREE  
 Cutout: 120x345mm  
 Input: 220V~240VAC  
 Wattage: 3x25W  
 Beam Angle: 15°/24°/36°  
 Color: Sand white/black  
 CCT: 2700~5500K  
 RA: ≥90

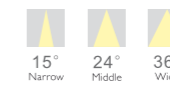
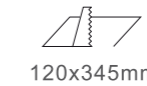

Adjustable



Certificate mark



IP rating



Different light colours



Excellent thermal management



Excellent visual comfort



Adjustable



Certificate mark



IP rating



Different light colours



Excellent thermal management



Excellent visual comfort

Grille Light

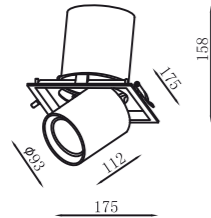

ROCA160160

LED: CITIZEN/CREE  
 Cutout: 160x160mm  
 Input: 220V~240VAC  
 Wattage: 1x35W  
 Beam Angle: 15°/24°/36°  
 Color: Sand white/black  
 CCT: 2700~5500K  
 RA: ≥90

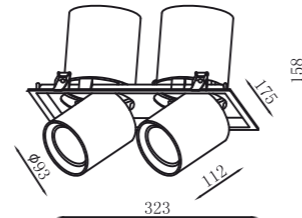
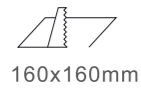

ROCA160305

LED: CITIZEN/CREE  
 Cutout: 160x305mm  
 Input: 220V~240VAC  
 Wattage: 2x25W  
 Beam Angle: 15°/24°/36°  
 Color: Sand white/black  
 CCT: 2700~5500K  
 RA: ≥90

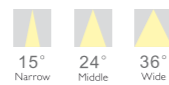
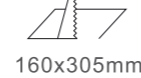

Adjustable



Certificate mark



IP rating



Different light colours



Excellent thermal management



Excellent visual comfort

Grille Light

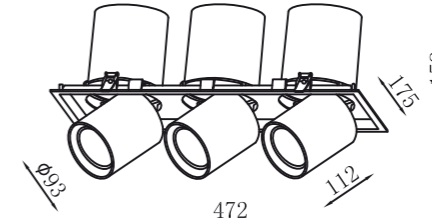

ROCA160450

LED: CITIZEN/CREE  
 Cutout: 160x450mm  
 Input: 220V~240VAC  
 Wattage: 3x35W  
 Beam Angle: 15°/24°/36°  
 Color: Sand white/black  
 CCT: 2700~5500K  
 RA: ≥90

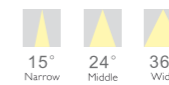
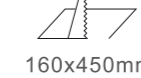

Adjustable



Certificate mark



IP rating



Different light colours



Excellent thermal management



Excellent visual comfort

Track Light

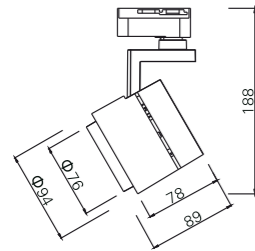

ROCATL02-A

Power: 15W  
 Voltage: 220V~240VAC 50/60Hz  
 Color temperature: 2700~5500K  
 Beam Angle: 15°/24°/40°  
 Color rendering index: ≥90  
 LED chip: COB

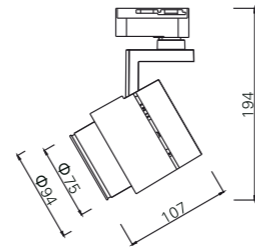

ROCATL02-B

Power: 20W  
 Voltage: 220V~240VAC 50/60Hz  
 Color temperature: 2700~5500K  
 Beam Angle: 15°/24°/40°  
 Color rendering index: ≥90  
 LED chip: COB

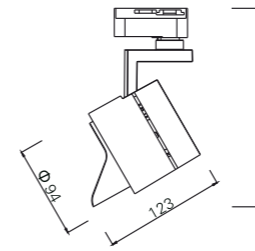

ROCATL02-C

Power: 20W  
 Voltage: 220V~240VAC 50/60Hz  
 Color temperature: 2700~5500K  
 Beam Angle: 15°/24°/40°  
 Color rendering index: ≥90  
 LED chip: COB

Track Light

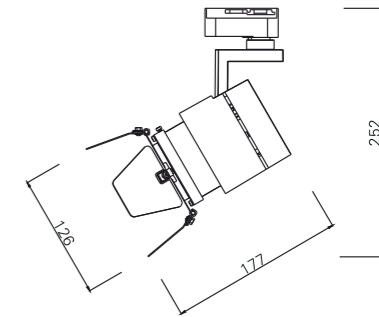

ROCATL02-D

Power: 20W  
 Voltage: 220V~240VAC 50/60Hz  
 Color temperature: 2700~5500K  
 Beam Angle: 15°/24°/40°  
 Color rendering index: ≥90  
 LED chip: COB



- 1 Non-Dim
- 2 0-10 V Dim
- 3 Triac dim
- 4 Dali dim
- 5 Mesh

FEATURES

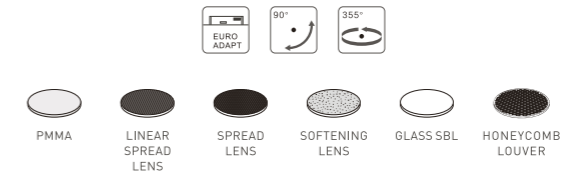

Adjustable



Certificate mark



IP rating



Different light colours



Excellent thermal management



Excellent visual comfort



Adjustable



Certificate mark



IP rating



Different light colours



Excellent thermal management



Excellent visual comfort



Ceiling Light

Track Light

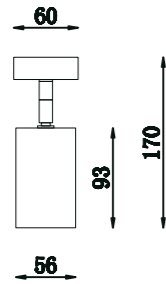

ROCA-CL1110

Power: 7W  
 Voltage: 220V~240VAC 50/60Hz  
 Color temperature: 2700~5500K  
 Beam Angle: 15°/24°/40°  
 Color rendering index: ≥90  
 LED chip: COB

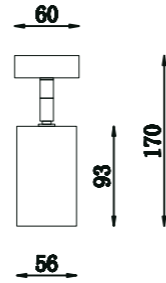

ROCA-CL1111

BULB: GU10  
 Voltage: 220V~240VAC 50/60Hz  
 Wattage: 40W  
 Installation: Ceiling Light

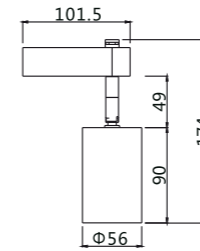

ROCA-TL1113

Power: 7W  
 Voltage: 220V~240VAC 50/60Hz  
 Color temperature: 2700~5500K  
 Beam Angle: 15°/24°/40°  
 Color rendering index: ≥90  
 LED chip: COB

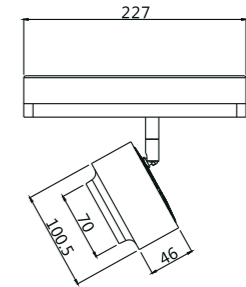

ROCA-TL1118

Power: 20W  
 Voltage: 220V~240VAC 50/60Hz  
 Color temperature: 2700~5500K  
 Beam Angle: 15°/24°/40°  
 Color rendering index: ≥90  
 LED chip: COB



Adjustable



Certificate mark



IP rating



Different light colours



Excellent thermal management



Excellent visual comfort



Adjustable



Certificate mark



IP rating



Different light colours



Excellent thermal management



Excellent visual comfort



Beam Angle

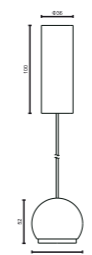
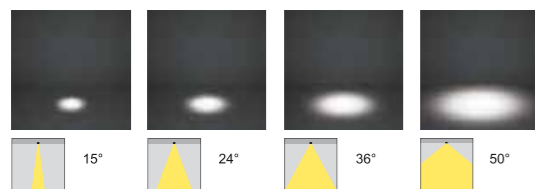

RC-MOD-PE0501

LED: OSRAM/CREE  
 Input: 220V~240VAC  
 Wattage: 5W  
 Beam Angle: 15°/24°/36°/50°  
 CCT: 2700~5500K  
 RA: ≥90

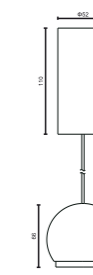

RC-MOD-PE0801

LED: OSRAM/CREE  
 Input: 220V~240VAC  
 Wattage: 8W  
 Beam Angle: 15°/24°/36°/50°  
 CCT: 2700~5500K  
 RA: ≥90



Fixed



Certificate mark



IP rating

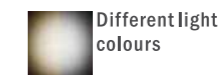

Different light colours



Excellent thermal management



Excellent visual comfort



# Pole



## Pole

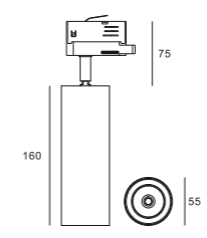

020097A

Power: 12W  
 Voltage: 220V~240VAC 50/60Hz  
 Color temperature: 2700~5500K  
 Beam Angle: 15°/24°/38°  
 Color rendering index: ≥80/90  
 LED chip: COB

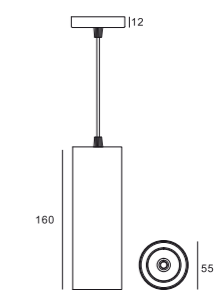

020097B

Power: 12W  
 Voltage: 220V~240VAC 50/60Hz  
 Color temperature: 2700~5500K  
 Beam Angle: 15°/24°/38°  
 Color rendering index: ≥80/90  
 LED chip: COB



Adjustable



Certificate mark



IP rating



Different light colours



Excellent thermal management



Excellent visual comfort

# Bamboo



## Bamboo

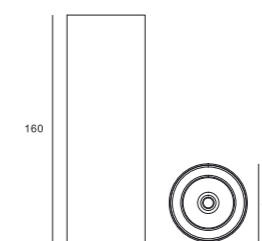

020098

Power: 12W/15W  
 Voltage: 220V~240VAC 50/60Hz  
 Color temperature: 2700~5500K  
 Beam Angle: 15°/24°/38°/60°  
 Color rendering index: ≥80/90  
 LED chip: COB



- 1 Non-Dim
- 2 0-10 V Dim
- 3 Triac dim
- 4 Dali dim
- 5 Mesh

### FEATURES



Fixed



Certificate mark



IP rating



Different light colours



Excellent thermal management



Excellent visual comfort





# Bamboo

Bamboo

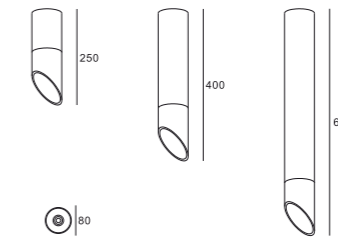

020098E

Power: 8W/10W  
 Voltage: 220V~240VAC 50/60Hz  
 Color temperature: 2700~5500K  
 Beam Angle: 15°/24°/38°  
 Color rendering index: ≥80/90  
 LED chip: COB



- 1 Non-Dim
- 2 0-10 V Dim
- 3 Triac dim
- 4 Dali dim
- 5 Mesh

FEATURES



Fixed



Certificate mark



IP rating



Different light colours



Excellent thermal management



Excellent visual comfort

Surface Mounted Downlight

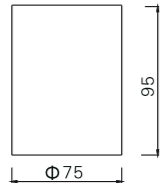
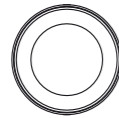

ROCA-CL1107

Power: 8W/12W  
 Voltage: 220V~240VAC 50/60Hz  
 Color temperature: 2700~5500K  
 Beam Angle: 24°  
 Color rendering index: ≥90  
 LED chip: COB

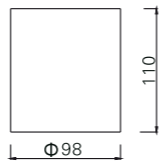
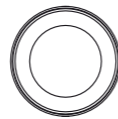

ROCA-CL1104

Power: 20W  
 Voltage: 220V~240VAC 50/60Hz  
 Color temperature: 2700~5500K  
 Beam Angle: 24°  
 Color rendering index: ≥90  
 LED chip: COB

Surface Mounted Downlight

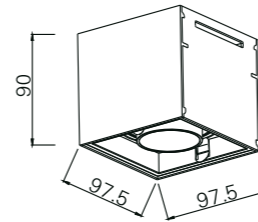

ROCA-CL1108

Power: 12W  
 Voltage: 220V~240VAC 50/60Hz  
 Color temperature: 2700~5500K  
 Beam Angle: 24°  
 Color rendering index: ≥90  
 LED chip: COB

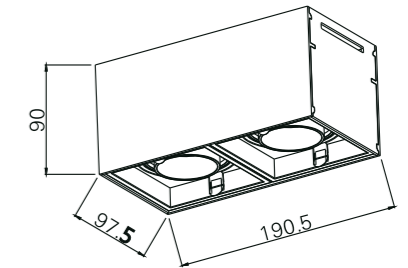

ROCA-CL1109

Power: 2x12W  
 Voltage: 220V~240VAC 50/60Hz  
 Color temperature: 2700~5500K  
 Beam Angle: 24°  
 Color rendering index: ≥90  
 LED chip: COB



Fixed



Certificate mark



IP rating



Different light colours



Excellent thermal management



Excellent visual comfort



Adjustable



Certificate mark



IP rating



Different light colours



Excellent thermal management



Excellent visual comfort



Surface Mounted Downlight

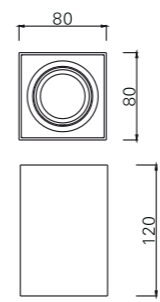

ROCA-CL1101

Power: 12W  
 Voltage: 220V~240VAC 50/60Hz  
 Color temperature: 2700~5500K  
 Beam Angle: 24°  
 Color rendering index: ≥90  
 LED chip: COB

- DIMMABLE
- 1 Non-Dim
  - 2 0-10 V Dim
  - 3 Triac dim
  - 4 Dali dim
  - 5 Mesh

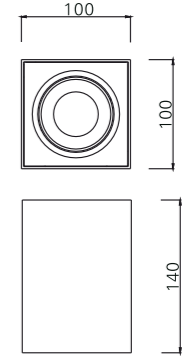

ROCA-CL1102

Power: 12W  
 Voltage: 220V~240VAC 50/60Hz  
 Color temperature: 2700~5500K  
 Beam Angle: 24°  
 Color rendering index: ≥90  
 LED chip: COB

- FEATURES
- Tuya BLE Mesh app



Fixed



Certificate mark



IP rating



Different light colours



Excellent thermal management



Excellent visual comfort



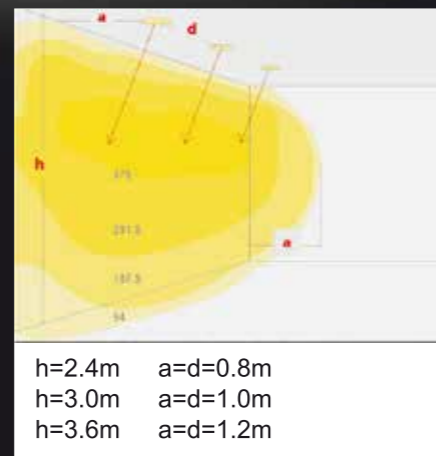
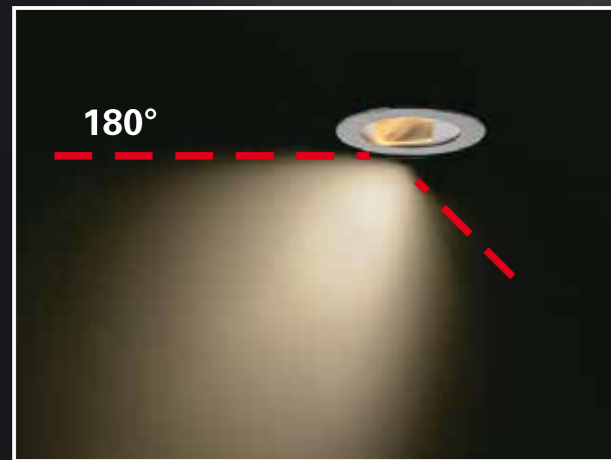

Unilateral polarized wash wall

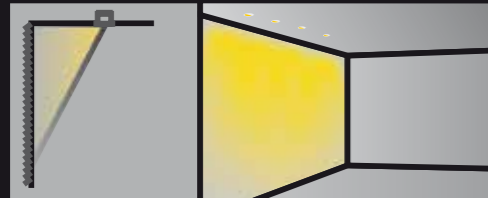

Bilateral polarized wash wall

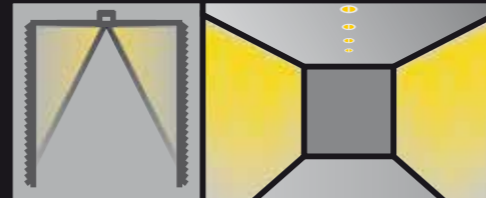

Rectangle light



Wall Washer

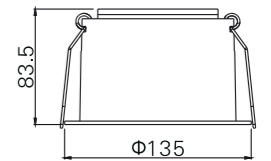
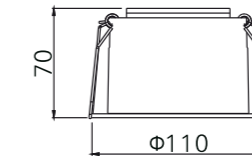
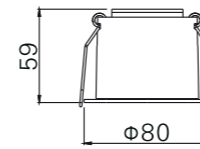

ROCA1134-12W

Power: 12W  
 Cutout:  $\Phi$ 70mm  
 Voltage: 220V~240VAC 50/60Hz  
 Color temperature: 2700~5500K  
 Beam Angle: 24°  
 Color rendering index:  $\geq$ 90  
 LED chip: COB



ROCA1134-20W

Power: 20W  
 Cutout:  $\Phi$ 95mm  
 Voltage: 220V~240VAC 50/60Hz  
 Color temperature: 2700~5500K  
 Beam Angle: 24°  
 Color rendering index:  $\geq$ 90  
 LED chip: COB



ROCA1134-30W

Power: 20W  
 Cutout:  $\Phi$ 125mm  
 Voltage: 220V~240VAC 50/60Hz  
 Color temperature: 2700~5500K  
 Beam Angle: 24°  
 Color rendering index:  $\geq$ 90  
 LED chip: COB



- DIMMABLE
- 1 Non-Dim
  - 2 0-10 V Dim
  - 3 Triac dim
  - 4 Dali dim
  - 5 Mesh

FEATURES



Wallwasher



Certificate mark



IP rating



Different light colours



Excellent thermal management



Excellent visual comfort



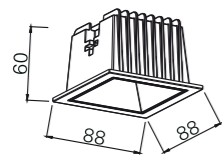

### ROCA1166-A

Power: 10-15W  
 Cutout: 75x75mm  
 Voltage: 220V~240VAC 50/60Hz  
 Color temperature: 2700~5500K  
 Beam Angle: 15°/24°/40°  
 Color rendering index: ≥90  
 LED chip: COB

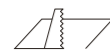

75x75mm

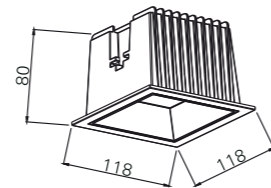

### ROCA1166-B

Power: 20W  
 Cutout: 105x105mm  
 Voltage: 220V~240VAC 50/60Hz  
 Color temperature: 2700~5500K  
 Beam Angle: 15°/24°/40°  
 Color rendering index: ≥90  
 LED chip: COB

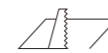

105x105mm

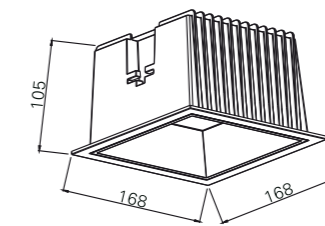

### ROCA1166-C

Power: 45W  
 Cutout: 150x150mm  
 Voltage: 220V~240VAC 50/60Hz  
 Color temperature: 2700~5500K  
 Beam Angle: 15°/24°/40°  
 Color rendering index: ≥90  
 LED chip: COB

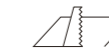

150x150mm

- DIMMABLE
- 1 Non-Dim
  - 2 0-10 V Dim
  - 3 Triac dim
  - 4 Dali dim
  - 5 Mesh

#### FEATURES



Fixed



Certificate mark



IP rating



Different light colours



Excellent thermal management



Excellent visual comfort



Fixed



Certificate mark



IP rating



Different light colours



Excellent thermal management



Excellent visual comfort



IP65



IP65

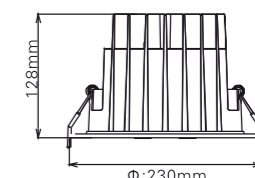
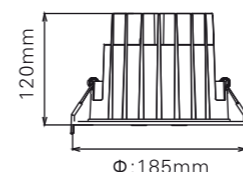
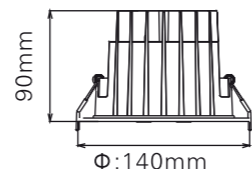
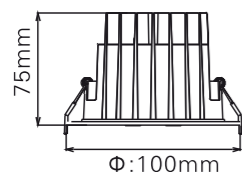

### ROCATD059-10

Power: 10W  
Cutout:  $\Phi$ 90mm  
Voltage: 220V~240VAC 50/60Hz  
Color temperature: 2700~5500K  
Beam Angle: 30°/45°  
Color rendering index:  $\geq$ 90  
LED chip: COB



$\Phi$ 90mm

### ROCATD059-20

Power: 20W  
Cutout:  $\Phi$ 130mm  
Voltage: 220V~240VAC 50/60Hz  
Color temperature: 2700~5500K  
Beam Angle: 30°/45°  
Color rendering index:  $\geq$ 90  
LED chip: COB



$\Phi$ :130mm

### ROCATD059-30

Power: 30W  
Cutout:  $\Phi$ 170mm  
Voltage: 220V~240VAC 50/60Hz  
Color temperature: 2700~5500K  
Beam Angle: 30°/45°  
Color rendering index:  $\geq$ 90  
LED chip: COB



$\Phi$ :170mm

### ROCATD059-40

Power: 40W  
Cutout:  $\Phi$ 200mm  
Voltage: 220V~240VAC 50/60Hz  
Color temperature: 2700~5500K  
Beam Angle: 30°/45°  
Color rendering index:  $\geq$ 90  
LED chip: COB

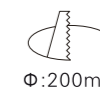

$\Phi$ :200mm

- DIMMABLE
- 1 Non-Dim
  - 2 0-10 V Dim
  - 3 Triac dim
  - 4 Dali dim
  - 5 Mesh

#### FEATURES



Fixed



Certificate mark



IP rating



Different light colours



Excellent thermal management



Excellent visual comfort



Fixed



Certificate mark



IP rating



Different light colours



Excellent thermal management



Excellent visual comfort



# OCEAN



Ocean

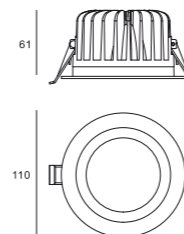

010161A

Power: 10W  
Cutout:  $\Phi$ 95mm  
Voltage: 220V~240VAC 50/60Hz  
Color temperature: 2700~5500K  
Beam Angle: 50°  
Color rendering index:  $\geq$ 90  
LED chip: COB



$\Phi$  95mm

- DIMMABLE
- 1 Non-Dim
  - 2 0-10 V Dim
  - 3 Triac dim
  - 4 Dali dim
  - 5 Mesh

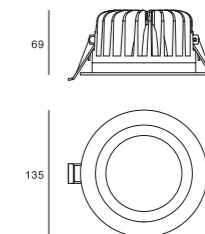

010161B

Power: 15W  
Cutout:  $\Phi$ 110mm  
Voltage: 220V~240VAC 50/60Hz  
Color temperature: 2700~5500K  
Beam Angle: 50°  
Color rendering index:  $\geq$ 90  
LED chip: COB



$\Phi$  110mm

### FEATURES



Fixed



Certificate mark



IP rating



Different light colours



Excellent thermal management



Excellent uniformity

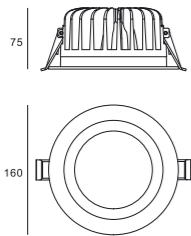

010161C

Power: 25-30W  
Cutout: Φ130mm  
Voltage: 220V~240VAC 50/60Hz  
Color temperature: 2700~5500K  
Beam Angle: 50°  
Color rendering index: ≥90  
LED chip: COB



Φ 130mm



Fixed



Certificate mark



IP rating



Different light colours



Excellent thermal management



Excellent uniformity

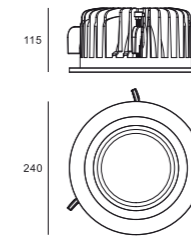

010161E

Power: 50W  
Cutout: Φ200mm  
Voltage: 220V~240VAC 50/60Hz  
Color temperature: 2700~5500K  
Beam Angle: 50°  
Color rendering index: ≥90  
LED chip: COB



Φ 200mm



Fixed



Certificate mark



IP rating



Different light colours



Excellent thermal management



Excellent uniformity



# DEEP

UGR<19



Deep

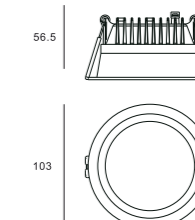
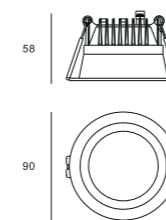

010170C01

010170C02

Power: 3/5W  
 Cutout:  $\Phi$ 75mm  
 Voltage: 220V~240VAC 50/60Hz  
 Color temperature: 3000~6000K  
 Beam Angle: 90°  
 Color rendering index:  $\geq$ 90  
 LED chip: SMD

Power: 7/10W  
 Cutout:  $\Phi$ 90mm  
 Voltage: 220V~240VAC 50/60Hz  
 Color temperature: 3000~6000K  
 Beam Angle: 90°  
 Color rendering index:  $\geq$ 90  
 LED chip: SMD



- 1 Non-Dim
- 2 0-10 V Dim
- 3 Triac dim
- 4 Dali dim
- 5 Mesh

### FEATURES



Fixed



Certificate mark



IP rating



Different light colours



Excellent thermal management



Excellent uniformity

Deep

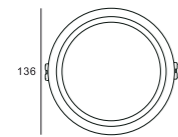
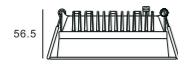

010170C03

Power: 12/15W  
Cutout:  $\Phi$ 120mm  
Voltage: 220V~240VAC 50/60Hz  
Color temperature: 3000~6000K  
Beam Angle: 90°  
Color rendering index:  $\geq$ 90  
LED chip: SMD



$\Phi$  120mm

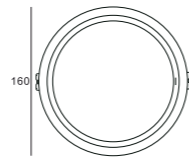

010170C04

Power: 17/20W  
Cutout:  $\Phi$ 145mm  
Voltage: 220V~240VAC 50/60Hz  
Color temperature: 3000~6000K  
Beam Angle: 90°  
Color rendering index:  $\geq$ 90  
LED chip: SMD



$\Phi$  145mm



Deep

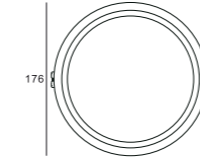
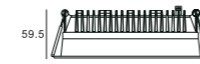

010170C05

Power: 20/25W  
Cutout:  $\Phi$ 160mm  
Voltage: 220V~240VAC 50/60Hz  
Color temperature: 3000~6000K  
Beam Angle: 90°  
Color rendering index:  $\geq$ 90  
LED chip: SMD



$\Phi$  160mm

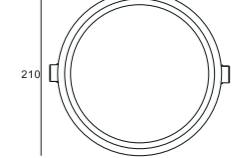
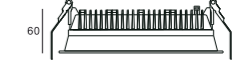

010170C06

Power: 30/35W  
Cutout:  $\Phi$ 200mm  
Voltage: 220V~240VAC 50/60Hz  
Color temperature: 3000~6000K  
Beam Angle: 90°  
Color rendering index:  $\geq$ 90  
LED chip: SMD



$\Phi$  200mm





# Neox

## Neox

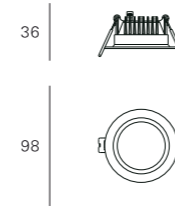

010170B01

Power: 3W  
 Cutout:  $\Phi$ 70mm  
 Voltage: 220V~240VAC 50/60Hz  
 Color temperature: 3000~4000K~6000K  
 Beam Angle: 112°  
 Color rendering index:  $\geq$ 90  
 LED chip: SMD



- DIMMABLE
- 1 Non-Dim
  - 2 0-10 V Dim
  - 3 Triac dim
  - 4 Dali dim
  - 5 Mesh

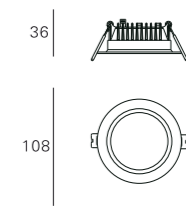

010170B02

Power: 5W  
 Cutout:  $\Phi$ 80mm  
 Voltage: 220V~240VAC 50/60Hz  
 Color temperature: 3000~4000K~6000K  
 Beam Angle: 112°  
 Color rendering index:  $\geq$ 90  
 LED chip: SMD

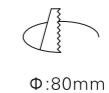

### FEATURES



Fixed



Certificate mark



IP rating

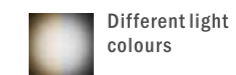

Different light colours



Excellent thermal management



Excellent uniformity

Neox

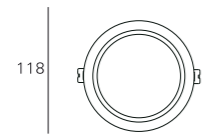

010170B03

Power: 7W  
Cutout:  $\Phi$ 90mm  
Voltage: 220V~240VAC 50/60Hz  
Color temperature: 3000~4000K~6000K  
Beam Angle: 112°  
Color rendering index:  $\geq$ 90  
LED chip: SMD



$\Phi$ :90mm

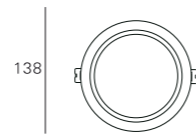

010170B04

Power: 9W  
Cutout:  $\Phi$ 115mm  
Voltage: 220V~240VAC 50/60Hz  
Color temperature: 3000~4000K~6000K  
Beam Angle: 112°  
Color rendering index:  $\geq$ 90  
LED chip: SMD



$\Phi$ :115mm

Neox

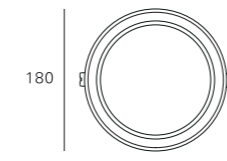

010170B05

Power: 12W  
Cutout:  $\Phi$ 155mm  
Voltage: 220V~240VAC 50/60Hz  
Color temperature: 3000~4000K~6000K  
Beam Angle: 112°  
Color rendering index:  $\geq$ 90  
LED chip: SMD



$\Phi$ :155mm

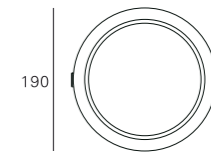

010170B06

Power: 20W  
Cutout:  $\Phi$ 160mm  
Voltage: 220V~240VAC 50/60Hz  
Color temperature: 3000~4000K~6000K  
Beam Angle: 112°  
Color rendering index:  $\geq$ 90  
LED chip: SMD



$\Phi$ :160mm

UGR  
 $\leq$ 19



PMMA



DIMMABLE

UGR  
 $\leq$ 19



PMMA



DIMMABLE



Fixed



Certificate  
mark



IP rating  
IP 20



Different light  
colours



Excellent  
thermal  
management



Excellent  
uniformity



Fixed



Certificate  
mark



IP rating  
IP 20



Different light  
colours



Excellent  
thermal  
management



Excellent  
uniformity



# Wall Washer



CH



GD



SL



BK



WH

## Wall Washer

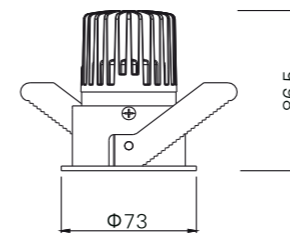

ROCA1132-10W

Power: 10W  
 Cutout:  $\Phi 65\text{mm}$   
 Voltage: 220V~240VAC 50/60Hz  
 Color temperature: 2700~5500K  
 Beam Angle: 24°  
 Color rendering index:  $\geq 90$   
 LED chip: COB



$\Phi: 65\text{mm}$

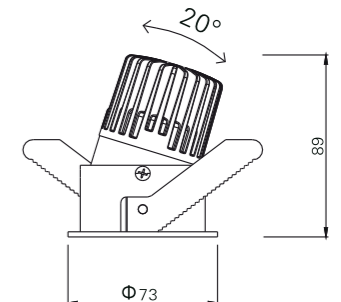

ROCA1132C-10W

Power: 10W  
 Cutout:  $\Phi 65\text{mm}$   
 Voltage: 220V~240VAC 50/60Hz  
 Color temperature: 2700~5500K  
 Beam Angle: 24°  
 Color rendering index:  $\geq 90$   
 LED chip: COB



$\Phi: 65\text{mm}$



Adjustable



Certificate mark



IP rating



Different light colours



Excellent thermal management



Excellent visual comfort

Wall Washer

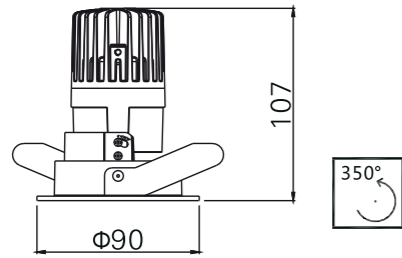

ROCA1132-12W

Power: 12W  
 Cutout: Φ75mm  
 Voltage: 220V~240VAC 50/60Hz  
 Color temperature: 2700~5500K  
 Beam Angle: 24°  
 Color rendering index: ≥90  
 LED chip: COB

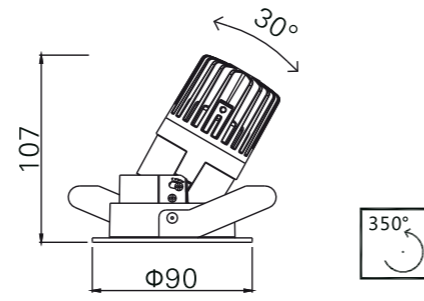

ROCA1132C-12W

Power: 12W  
 Cutout: Φ75mm  
 Voltage: 220V~240VAC 50/60Hz  
 Color temperature: 2700~5500K  
 Beam Angle: 24°  
 Color rendering index: ≥90  
 LED chip: COB



Wall Washer

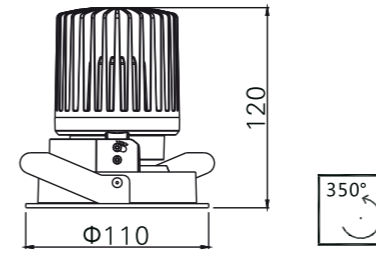

ROCA1132-20W

Power: 20W  
 Cutout: Φ100mm  
 Voltage: 220V~240VAC 50/60Hz  
 Color temperature: 2700~5500K  
 Beam Angle: 24°  
 Color rendering index: ≥90  
 LED chip: COB

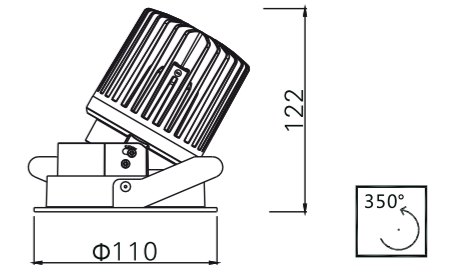
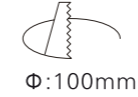

ROCA1132C-20W

Power: 20W  
 Cutout: Φ100mm  
 Voltage: 220V~240VAC 50/60Hz  
 Color temperature: 2700~5500K  
 Beam Angle: 24°  
 Color rendering index: ≥90  
 LED chip: COB



Wall Washer

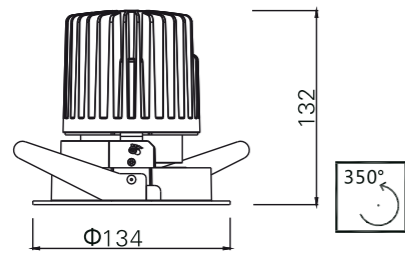

ROCA1132-30W

Power: 30W  
 Cutout:  $\Phi$ 125mm  
 Voltage: 220V~240VAC 50/60Hz  
 Color temperature: 2700~5500K  
 Beam Angle: 24°  
 Color rendering index:  $\geq$ 90  
 LED chip: COB



$\Phi$ :125mm

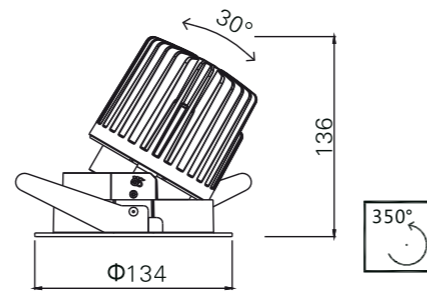

ROCA1132C-30W

Power: 12W  
 Cutout:  $\Phi$ 125mm  
 Voltage: 220V~240VAC 50/60Hz  
 Color temperature: 2700~5500K  
 Beam Angle: 24°  
 Color rendering index:  $\geq$ 90  
 LED chip: COB



$\Phi$ :125mm

Wall Washer

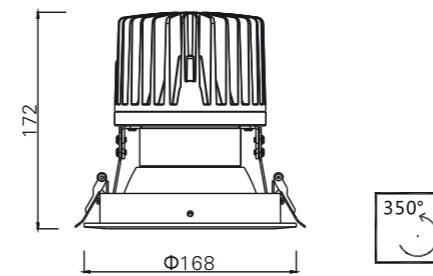

ROCA1132-40W

Power: 40W  
 Cutout:  $\Phi$ 150mm  
 Voltage: 220V~240VAC 50/60Hz  
 Color temperature: 2700~5500K  
 Beam Angle: 24°  
 Color rendering index:  $\geq$ 90  
 LED chip: COB

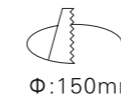

$\Phi$ :150mm

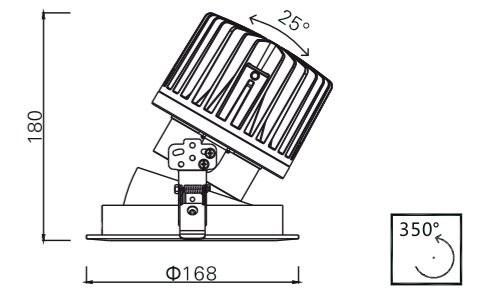

ROCA1132C-40W

Power: 40W  
 Cutout:  $\Phi$ 150mm  
 Voltage: 220V~240VAC 50/60Hz  
 Color temperature: 2700~5500K  
 Beam Angle: 24°  
 Color rendering index:  $\geq$ 90  
 LED chip: COB



$\Phi$ :150mm



Adjustable



Certificate mark



IP rating



Different light colours



Excellent thermal management



Excellent visual comfort



Adjustable



Certificate mark



IP rating



Different light colours



Excellent thermal management



Excellent visual comfort





Anti-glare Downlight

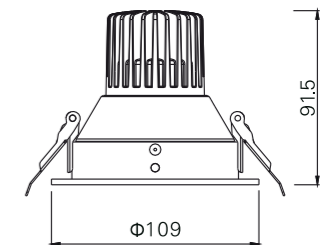
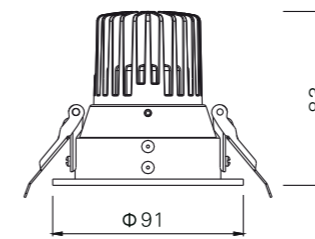

ROCA1118-6

ROCA1119-10

Power: 6-10W  
 Cutout:  $\Phi$ 75mm  
 Voltage: 220V~240VAC 50/60Hz  
 Color temperature: 2700~5500K  
 Beam Angle: 24°/40°  
 Color rendering index:  $\geq$ 90  
 LED chip: COB

Power: 6-12W  
 Cutout:  $\Phi$ 95mm  
 Voltage: 220V~240VAC 50/60Hz  
 Color temperature: 2700~5500K  
 Beam Angle: 24°/40°  
 Color rendering index:  $\geq$ 90  
 LED chip: COB



Fixed



Certificate mark



IP rating



Different light colours



Excellent thermal management

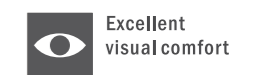

Excellent visual comfort



Anti-glare Downlight

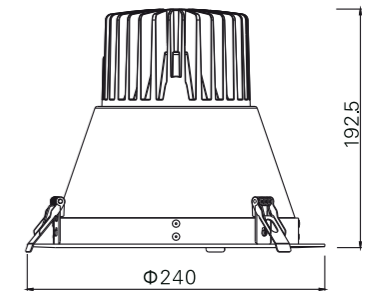
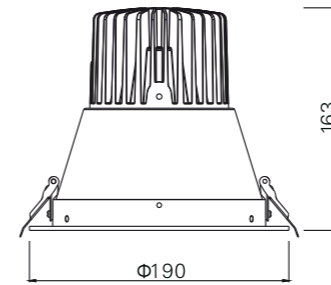
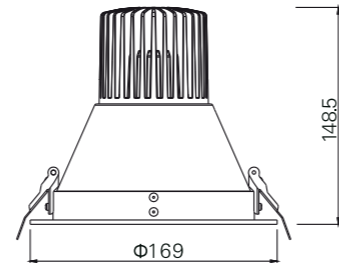
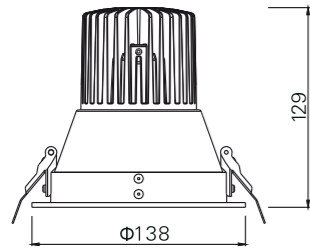

ROCA1120-20

Power: 15-20W  
 Cutout:  $\Phi$ 125mm  
 Voltage: 220V~240VAC 50/60Hz  
 Color temperature: 2700~5500K  
 Beam Angle: 24°/40°  
 Color rendering index:  $\geq$ 90  
 LED chip: COB

ROCA1121-30

Power: 30W  
 Cutout:  $\Phi$ 150mm  
 Voltage: 220V~240VAC 50/60Hz  
 Color temperature: 2700~5500K  
 Beam Angle: 24°/40°  
 Color rendering index:  $\geq$ 90  
 LED chip: COB

ROCA1122-35

Power: 36W  
 Cutout:  $\Phi$ 170mm  
 Voltage: 220V~240VAC 50/60Hz  
 Color temperature: 2700~5500K  
 Beam Angle: 24°/40°  
 Color rendering index:  $\geq$ 90  
 LED chip: COB

ROCA1123-40

Power: 6-12W  
 Cutout:  $\Phi$ 210mm  
 Voltage: 220V~240VAC 50/60Hz  
 Color temperature: 2700~5500K  
 Beam Angle: 24°/40°  
 Color rendering index:  $\geq$ 90  
 LED chip: COB

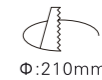
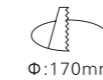

Fixed



Certificate mark



IP rating



Different light colours



Excellent thermal management



Excellent visual comfort



Fixed



Certificate mark



IP rating



Different light colours



Excellent thermal management



Excellent visual comfort

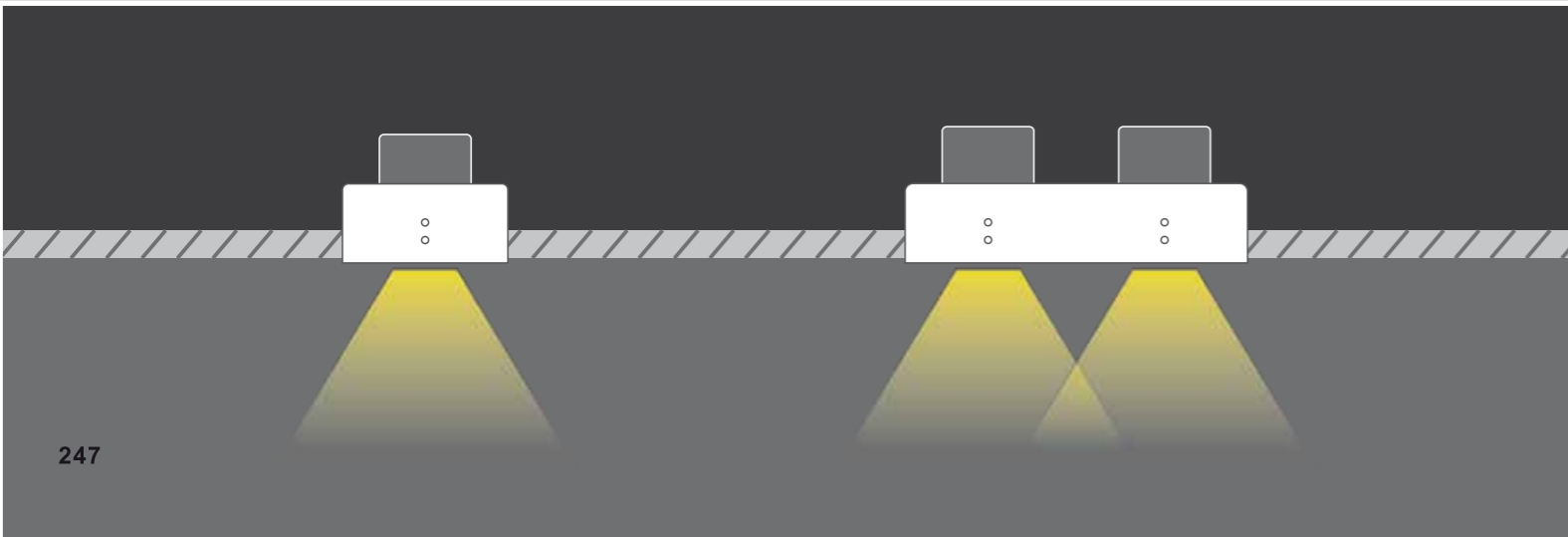
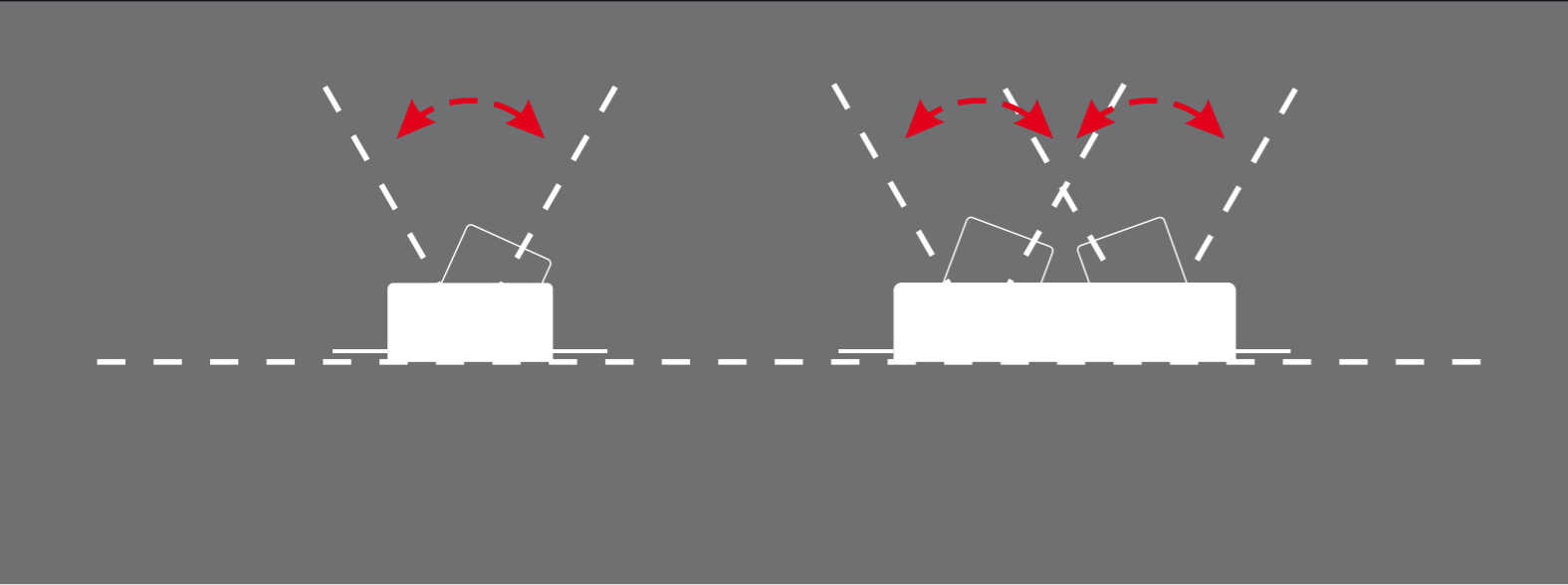

Grille Light

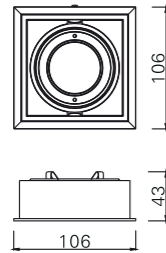

ROCA-GL1114

Power: 10W  
 Cutout: 100x100mm  
 Voltage: 220V~240VAC 50/60Hz  
 Color temperature: 2700~5500K  
 Beam Angle: 15°/24°/40°  
 Color rendering index: ≥90  
 LED chip: COB

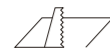

100x100mm

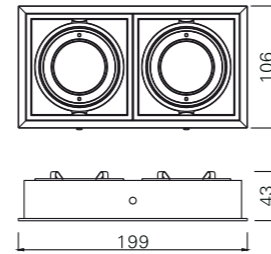
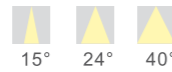

ROCA-GL1115

Power: 2x10W  
 Cutout: 195x100mm  
 Voltage: 220V~240VAC 50/60Hz  
 Color temperature: 2700~5500K  
 Beam Angle: 15°/24°/40°  
 Color rendering index: ≥90  
 LED chip: COB

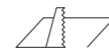

195x100mm

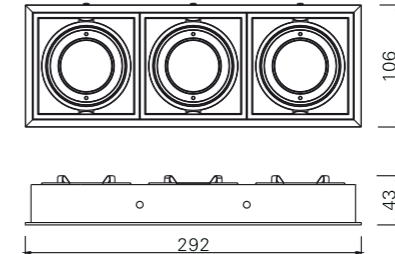

ROCA-GL1116

Power: 3x10W  
 Cutout: 285x100mm  
 Voltage: 220V~240VAC 50/60Hz  
 Color temperature: 2700~5500K  
 Beam Angle: 15°/24°/40°  
 Color rendering index: ≥90  
 LED chip: COB

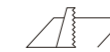

285x100mm



- 1 Non-Dim
- 2 0-10 V Dim
- 3 Triac dim
- 4 Dali dim
- 5 Mesh

FEATURES



Adjustable



Certificate mark



IP rating



Different light colours



Excellent thermal management



Excellent visual comfort



Adjustable



Certificate mark



IP rating



Different light colours



Excellent thermal management



Excellent visual comfort

Grille Light

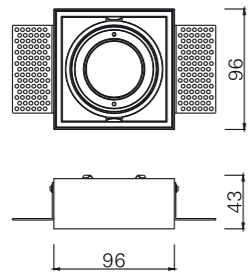

ROCA-GL1117

Power: 15W  
 Cutout: 100x100mm  
 Voltage: 220V~240VAC 50/60Hz  
 Color temperature: 2700~5500K  
 Beam Angle: 15°/24°/40°  
 Color rendering index: ≥90  
 LED chip: COB

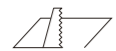

100x100mm



15° 24° 40°

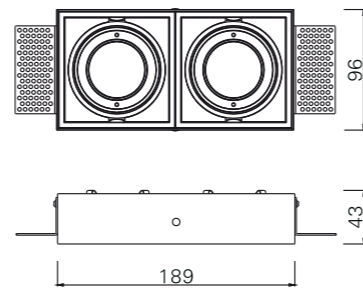

ROCA-GL1118

Power: 2x15W  
 Cutout: 195x100mm  
 Voltage: 220V~240VAC 50/60Hz  
 Color temperature: 2700~5500K  
 Beam Angle: 15°/24°/40°  
 Color rendering index: ≥90  
 LED chip: COB

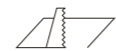

195x100mm

Grille Light

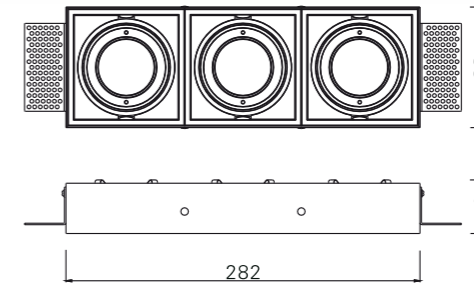

ROCA-GL1119

Power: 3x15W  
 Cutout: 285x100mm  
 Voltage: 220V~240VAC 50/60Hz  
 Color temperature: 2700~5500K  
 Beam Angle: 15°/24°/40°  
 Color rendering index: ≥90  
 LED chip: COB

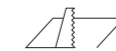

285x100mm



DIMMABLE

- 1 Non-Dim
- 2 0-10 V Dim
- 3 Triac dim
- 4 Dali dim
- 5 Mesh

FEATURES



tuya BLE Mesh app



Adjustable



Certificate mark



IP rating



Different light colours



Excellent thermal management



Excellent visual comfort



Adjustable



Certificate mark



IP rating



Different light colours



Excellent thermal management



Excellent visual comfort



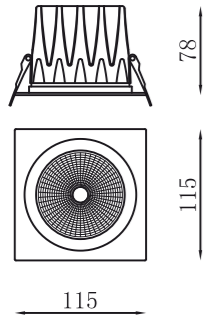

### ROCA-1002FS-95Q

LED: PHILIPS/CREE/LUMILEDS  
 Size: 115xH78 mm  
 Cutout:  $\Phi$ 95mm  
 Light efficiency:  $\geq$ 90ml/W  
 Input: 220V-240V  
 Wattage: 15W  
 Beam Angle: 50°  
 CCT: 2700K~6000K  
 RA: 90

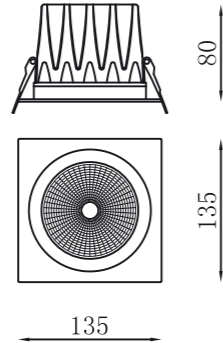

### ROCA-1002FS-120Q

LED: PHILIPS/CREE/LUMILEDS  
 Size: 135xH80 mm  
 Cutout:  $\Phi$ 120mm  
 Light efficiency:  $\geq$ 90ml/W  
 Input: 220V-240V  
 Wattage: 20W  
 Beam Angle: 50°  
 CCT: 2700K~6000K  
 RA: 90

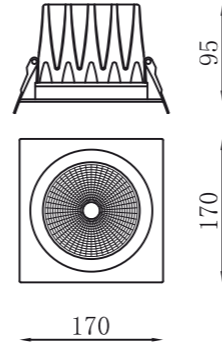

### ROCA-1002FS-150Q

LED: PHILIPS/CREE/LUMILEDS  
 Size: 170xH95 mm  
 Cutout:  $\Phi$ 150mm  
 Light efficiency:  $\geq$ 90ml/W  
 Input: 220V-240V  
 Wattage: 30W  
 Beam Angle: 50°  
 CCT: 2700K~6000K  
 RA: 90

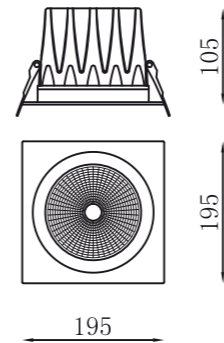

### ROCA-1002FS-170Q

LED: PHILIPS/CREE/LUMILEDS  
 Size: 195xH105 mm  
 Cutout:  $\Phi$ 170mm  
 Light efficiency:  $\geq$ 90ml/W  
 Input: 220V-240V  
 Wattage: 40W  
 Beam Angle: 50°  
 CCT: 2700K~6000K  
 RA: 90

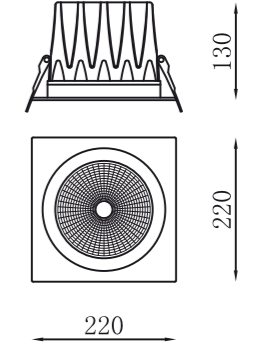

### ROCA-1002FS-200Q

LED: PHILIPS/CREE/LUMILEDS  
 Size: 220xH130 mm  
 Cutout:  $\Phi$ 200mm  
 Light efficiency:  $\geq$ 90ml/W  
 Input: 220V-240V  
 Wattage: 50W  
 Beam Angle: 50°  
 CCT: 2700K~6000K  
 RA: 90

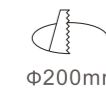

Fixed



Certificate mark



IP rating



Different light distributions



Excellent thermal management



Excellent visual comfort



Fixed



Certificate mark



IP rating



Different light distributions



Excellent thermal management



Excellent visual comfort

EUROPA:  
ITALY  
Via Ghisolfa  
80/e 20010  
Cornaredo (MI)  
[www.sirioluce.com](http://www.sirioluce.com)

[info@sirioluce.com](mailto:info@sirioluce.com)

SIRIO Luce  
Italian Style



SIRIO Luce  
Italian Style